

Hydraulic induction chafing dish



LID POSITION
 OPEN UP TO MAXIMUM 90°
 STAYS OPEN AT 70°
 INITIATE TO CLOSE BY PRESSING DOWN GENTLY
 LID FALLS & CLOSES AUTOMATICALLY & SILENTLY
 炉盖开启角度: 90° / 70°

HYDRAULIC HINGE
 FOR SMOOTH OPENING & CLOSING LID
 液压铰链: 保持炉盖开合顺畅宁静

HYDRAULIC HINGE
 FOR SMOOTH OPENING & CLOSING LID
 液压铰链: 保持炉盖开合顺畅宁静

ADJUSTABLE LEVEL SUPPORT
 for a perfectly level placement when required
 水平调节: 调整适当支撑高度 稳定水盆

NOTCH
 CHANGING FOOD PAN EASILY
 凹位: 快捷更换食物盆位置

CAPSULED BOTTOM
 CAPSULE-SANDWICH INDUCTION BASE FOR FAST & EVEN HEATING
 复合包底

- YUFEH's delux induction chafing dish.**
- YUFEH's delux induction chafing dish.
 - With Elegant design and practical funtion.
 - The dish itself can compatible with induction plates or along with matching frame for a more classic buffet environment.
 - Heat source like induction plates, electrical warmer and sterno are all suitable.
 - The patented hydraulic mechanism gives an extremely smooth lid motion. Gentle & silent opening & closing of lid which helps to define the class of a buffet
- 宇辉2013年最新系列自助餐炉
 - 优雅简洁的设计和强大的实用性功能
 - 可独立使用于电磁炉或电热板上, 亦可选配炉架, 使用电磁炉或燃料.
 - 最新注册设计的液压系统结构, 在使用过程中, 保持炉盖开合顺畅宁静



3011

FULL SIZE INDUCTION CHAFING DISH
 OPTIONAL GN1/1 FOOD PAN,9Ltr
 MATHCING STAND 3011F
 SPEC./产品尺寸
 BODY上装: 57.5X45.3X21.4CM
 FRAME下装: 59X38.5X17.4CM
 MEAS./包装尺寸:
 BODY上装: 58X45.5X25CM
 FRAME下装: 59.5X39.5X19CM
 长方型液压式钢盖高级餐炉
 可配GN1/1食物盆.9升
 炉架: 3011F

3011L

FULL SIZE INDUCTION CHAFING DISH
 W/ GLASS WINDOWED LID
 OPTIONAL GN1/1 FOOD PAN,9Ltr
 MATHCING STAND 3011F
 SPEC./产品尺寸
 BODY上装: 57.5X45.3X21.4CM
 FRAME下装: 59X38.5X17.4CM
 MEAS./包装尺寸:
 BODY上装: 58X45.5X25CM
 FRAME下装: 59.5X39.5X19CM
 长方型液压式玻璃盖高级餐炉
 配玻璃盖
 可配GN1/1食物盆.9升
 炉架: 3011F

3011F

3011F
 HEAT SOURCE:
 INDUCTION COOKER
 ELECTRICAL WARMER
 炉架可搭配电磁炉,电热板

OPTIONAL ACCESSORIES:
 VITRIFIED NON-POROUS PORCELAIN
 FOOD PAN
 可使用: 强化瓷食物盆

- P811-2**
GN 1/1 FOOD PAN 9Ltr
- P812-2**
GN 1/2 FOOD PAN 4Ltr
- P823-2**
GN 2/3 FOOD PAN 6Ltr
- P823/2-2**
GN 2/3 DIVIDED FOOD PAN 6Ltr
- P813-2**
GN 1/3 FOOD PAN 2.5Ltr

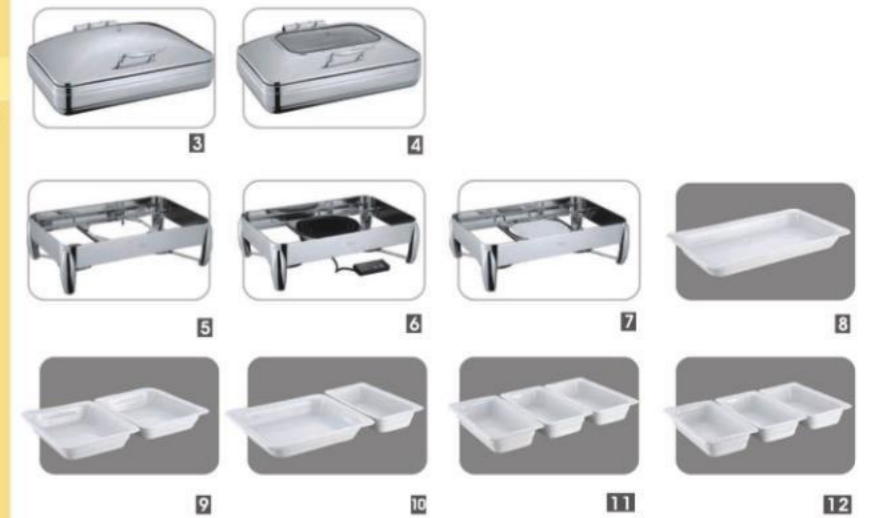

30 series hydraulic induction chafing dish

3032

2/3 SIZE INDUCTION CHAFING DISH
OPTIONAL GN2/3 FOOD PAN, 6Ltr
MATCHING STAND 3032F

SPEC./产品尺寸

BODY上装: 45X40.5X21.5CM

FRAME下装: 42X38X17.4CM

MEAS./包装尺寸:

BODY上装: 45.5X41.5X24.5CM

FRAME下装: 43X39X19CM

方型液压式钢盖高级餐炉

可配GN2/3食物盆.6升

炉架: 3032F



3032L

2/3 SIZE INDUCTION CHAFING DISH
W/ GLASS WINDOWED LID
OPTIONAL GN2/3 FOOD PAN, 6Ltr
MATCHING STAND 3032F

SPEC./产品尺寸

BODY上装: 45X40.5X21.5CM

FRAME下装: 42X38X17.4CM

MEAS./包装尺寸:

BODY上装: 45.5X41.5X24.5CM

FRAME下装: 43X39X19CM

方型液压式玻璃盖高级餐炉

配玻璃盖

可配GN2/3食物盆.6升

炉架: 3032F



3032F

3032F

HEAT SOURCE:
INDUCTION COOKER
ELECTRICAL WARMER
炉架可搭配电磁炉,电热板

OPTIONAL ACCESSORIES:
VITRIFIED NON-POROUS PORCELAIN
FOOD PAN
可使用: 强化瓷食物盆

P823-2

GN 2/3 FOOD PAN 6Ltr

P823/2-2

GN 2/3 DIVIDED FOOD PAN 6Ltr



30 series hydraulic induction chafing dish

YUFEH
Kitchen Ware

3021

HALF SIZE INDUCTION CHAFING DISH
OPTIONAL GN1/2 FOOD PAN, 4Ltr
MATCHING STAND 3021F

SPEC./产品尺寸

BODY上装: 44.7X31.5X21CM

FRAME下装: 39X32.5X17.4CM

MEAS./包装尺寸:

BODY上装: 45X32X25.5CM

FRAME下装: 39.5X33.5X19CM

方型液压式钢盖高级餐炉

可配GN1/2食物盆.4升

炉架: 3021F



3021L

HALF SIZE INDUCTION CHAFING DISH
W/ GLASS WINDOWED LID
OPTIONAL GN1/2 FOOD PAN, 4Ltr
MATCHING STAND 3021F

SPEC./产品尺寸

BODY上装: 44.7X31.5X21CM

FRAME下装: 39X32.5X17.4CM

MEAS./包装尺寸:

BODY上装: 45X32X25.5CM

FRAME下装: 39.5X33.5X19CM

方型液压式玻璃盖高级餐炉

配玻璃盖

可配GN1/2食物盆.4升

炉架: 3021F



3021F

P821F

HEAT SOURCE:
INDUCTION COOKER
ELECTRICAL WARMER
炉架可搭配电磁炉,电热板

OPTIONAL ACCESSORIES:
VITRIFIED NON-POROUS PORCELAIN
FOOD PAN
可使用: 强化瓷食物盆

P812-2

GN 1/2 FOOD PAN 4Ltr



30 series hydraulic induction chafing dish

30 series hydraulic induction chafing dish

YUFEH
Kitchen Ware

3060

ROUND INDUCTION CHAFING DISH
OPTIONAL Φ 35CM FOOD PAN, 6Ltr
MATCHING STAND 3060F
SPEC./产品尺寸
BODY上装: 50.5X43.5X21.7CM
FRAME下装: 44.7X44.7X17.4CM
MEAS./包装尺寸:
BODY上装: 51.5X45X25CM
FRAME下装: 45X45X19CM

圆型液压式钢盖高级餐炉
可配 Φ 35CM, 6升食物盆
炉架: 3060F

3060L

ROUND INDUCTION CHAFING DISH
W/ GLASS WINDOWED LID
OPTIONAL Φ 35CM FOOD PAN, 6Ltr
MATCHING STAND 3060F
SPEC./产品尺寸
BODY上装: 50.5X43.5X21.7CM
FRAME下装: 44.7X44.7X17.4CM
MEAS./包装尺寸:
BODY上装: 51.5X45X25CM
FRAME下装: 45X45X19CM

圆型液压式玻璃盖高级餐炉
配玻璃盖
可配 Φ 35CM, 6升食物盆
炉架: 3060F

3060F

3060F

HEAT SOURCE:
INDUCTION COOKER
ELECTRICAL WARMER
炉架可搭配电磁炉, 电热板

OPTIONAL ACCESSORIES:
VITRIFIED NON-POROUS PORCELAIN
FOOD PAN
可使用: 强化瓷食物盆

PRF36/2-2

Φ 33CM ROUND DIVIDED FOOD PAN,
5.8Ltr

PRF36-2

Φ 33CM ROUND FOOD PAN, 6Ltr



3040

ROUND INDUCTION CHAFING DISH
OPTIONAL Φ 30CM FOOD PAN, 4Ltr
MATCHING STAND 3040F
SPEC./产品尺寸
BODY上装: 43X39X21.8CM
FRAME下装: 37.7X37.7X17.2CM
MEAS./包装尺寸:
BODY上装: 44.5X38X25CM
FRAME下装: 38X38X19CM

圆型液压式钢盖高级餐炉
可配 Φ 30CM, 4升食物盆
炉架: 3040F

3040L

ROUND INDUCTION CHAFING DISH
W/ GLASS WINDOWED LID
OPTIONAL Φ 30CM FOOD PAN, 4Ltr
MATCHING STAND 3040F
SPEC./产品尺寸
BODY上装: 43X39X21.8CM
FRAME下装: 37.7X37.7X17.2CM
MEAS./包装尺寸:
BODY上装: 44.5X38X25CM
FRAME下装: 38X38X19CM

圆型液压式玻璃盖高级餐炉
配玻璃盖
可配 Φ 30CM, 4升食物盆
炉架: 3040F

3040F

3040F

HEAT SOURCE:
INDUCTION COOKER
ELECTRICAL WARMER
炉架可搭配电磁炉, 电热板

OPTIONAL ACCESSORIES:
VITRIFIED NON-POROUS PORCELAIN
FOOD PAN
可使用: 强化瓷食物盆

PRF28/2-2

Φ 28CM ROUND DIVIDED FOOD PAN,
3.8Ltr

PRF28-2

Φ 28CM ROUND FOOD PAN, 4Ltr



30 series hydraulic induction chafing dish

30 series hydraulic induction chafing dish

YUFEH
Kitchen Ware

30-11

ROUND INDUCTION SOUP STATION
OPTIONAL 11L SOUP BUCKET
MATCHING STAND 30-11F
SPEC./产品尺寸
BODY上装: 45X39.5X34.5CM
FRAME下装: 37.7X37.7X17.2CM
MEAS./包装尺寸:
BODY上装: 46X40.5X37.5CM
FRAME下装: 38X38X19CM

圆型液压式钢盖高级汤炉
可配11升汤桶
炉架: 30-11F



1



3



4



5



6



7



8

30-11L

ROUND INDUCTION SOUP STATION
W/ GLASS WINDOWED LID
OPTIONAL 11L SOUP BUCKET
MATCHING STAND 30-11F
SPEC./产品尺寸
BODY上装: 45X39.5X34.5CM
FRAME下装: 37.7X37.7X17.2CM
MEAS./包装尺寸:
BODY上装: 46X40.5X37.5CM
FRAME下装: 38X38X19CM

圆型液压式玻璃盖高级汤炉
配玻璃盖
可配11L汤桶
炉架: 30-11F



2

30-11F

30-11F

HEAT SOURCE:
INDUCTION COOKER
ELECTRICAL WARMER
炉架可搭配电磁炉, 电热板

11L INSERT SOUP BUCKET
11升汤桶

3011/2F

FULL SIZE INDUCTION CHAFING DISH
OPTIONAL GN1/1 FOOD PAN, 9Ltr
MATCHING STAND 2011F
SPEC./产品尺寸
BODY上装: 57.5X45.3X21.4CM
FRAME下装: 66.5X37.7X18.5CM
MEAS./包装尺寸:
BODY上装: 58X45.5X25CM
FRAME下装: 67X38X20CM

长方型液压式钢盖高级餐炉
可配GN1/1食物盆, 9升
炉架: 2011F

3011L/2F

FULL SIZE INDUCTION CHAFING DISH
W/ GLASS WINDOWED LID
OPTIONAL GN1/1 FOOD PAN, 9Ltr
MATCHING STAND 2011F
SPEC./产品尺寸
BODY上装: 57.5X45.3X21.4CM
FRAME下装: 66.5X37.7X18.5CM
MEAS./包装尺寸:
BODY上装: 58X45.5X25CM
FRAME下装: 67X38X20CM

长方型液压式玻璃盖高级餐炉
配玻璃盖
可配GN1/1食物盆, 9升
炉架: 2011F

2011F

HEAT SOURCE:
INDUCTION COOKER
ELECTRICAL WARMER
炉架可搭配电磁炉, 电热板

OPTIONAL ACCESSORIES:
VITRIFIED NON-POROUS PORCELAIN
FOOD PAN
可使用: 强化瓷食物盆

P811-2

GN 1/1 FOOD PAN 9Ltr

P812-2

GN 1/2 FOOD PAN 4Ltr

P823-2

GN 2/3 FOOD PAN 6Ltr

P823/2-2

GN 2/3 DIVIDED FOOD PAN 6Ltr

P813-2

GN 1/3 FOOD PAN 2.5Ltr



1



3



4



5



6



7



8



9



10



11



2

30 series hydraulic induction chafing dish

3032/2F

2/3 SIZE INDUCTION CHAFING DISH
OPTIONAL GN2/3 FOOD PAN, 6Ltr
MATCHING STAND 2032F

SPEC./产品尺寸

BODY上装: 45X40.5X21.5CM
FRAME下装: 49X37.7X18.5CM

MEAS./包装尺寸:

BODY上装: 45.5X41.5X24.5CM
FRAME下装: 49.5X38X20CM

方型液压式钢盖高级餐炉
可配GN2/3食物盆.6升
炉架: 2032F



1

3032L/2F

2/3 SIZE INDUCTION CHAFING DISH
W/ GLASS WINDOWED LID
OPTIONAL GN2/3 FOOD PAN, 6Ltr
MATCHING STAND 2032F

SPEC./产品尺寸

BODY上装: 45X40.5X21.5CM
FRAME下装: 49X37.7X18.5CM

MEAS./包装尺寸:

BODY上装: 45.5X41.5X24.5CM
FRAME下装: 49.5X38X20CM

方型液压式玻璃盖高级餐炉
配玻璃盖
可配GN2/3食物盆.6升
炉架: 2032F



3



4



5



6



7



8

2032F

HEAT SOURCE:
INDUCTION COOKER
ELECTRICAL WARMER
炉架可搭配电磁炉,电热板

OPTIONAL ACCESSORIES:
VITRIFIED NON-POROUS PORCELAIN
FOOD PAN
可使用: 强化瓷食物盆

P823-2

GN 2/3 FOOD PAN 6Ltr

P823/2-2

GN 2/3 DIVIDED FOOD PAN 6Ltr



2

3021/2F

HALF SIZE INDUCTION CHAFING DISH
OPTIONAL GN1/2 FOOD PAN, 4Ltr
MATCHING STAND 2021F

SPEC./产品尺寸

BODY上装: 44.7X31.5X21CM
FRAME下装: 37.5X40X18.5CM

MEAS./包装尺寸:

BODY上装: 45X32X25.5CM
FRAME下装: 38X40.5X20CM

方型液压式钢盖高级餐炉
可配GN1/2食物盆.4升
炉架: 2021F



1

3021L/2F

HALF SIZE INDUCTION CHAFING DISH
W/ GLASS WINDOWED LID
OPTIONAL GN1/2 FOOD PAN, 4Ltr
MATCHING STAND 2021F

SPEC./产品尺寸

BODY上装: 44.7X31.5X21CM
FRAME下装: 37.5X40X18.5CM

MEAS./包装尺寸:

BODY上装: 45X32X25.5CM
FRAME下装: 38X40.5X20CM

方型液压式玻璃盖高级餐炉
配玻璃盖
可配GN1/2食物盆.4升
炉架: 2021F



3



4



5



6



7

2021F

HEAT SOURCE:
INDUCTION COOKER
ELECTRICAL WARMER
炉架可搭配电磁炉,电热板

OPTIONAL ACCESSORIES:
VITRIFIED NON-POROUS PORCELAIN
FOOD PAN
可使用: 强化瓷食物盆

P812-2

GN 1/2 FOOD PAN 4Ltr



2

30 series hydraulic induction
chafing dish

YUFEH
Kitchen Ware

30 series hydraulic induction chafing dish

3060/2F

ROUND INDUCTION CHAFING DISH
OPTIONAL Φ 35CM FOOD PAN, 6Ltr
MATCHING STAND 2060F
SPEC./产品尺寸
BODY上装: 50.5X43.5X21.7CM
FRAME下装: 44.5X44.5X18.5CM
MEAS./包装尺寸:
BODY上装: 45.5X41.5X24.5CM
FRAME下装: 45X45X20CM

圆型液压式钢盖高级餐炉
可配 Φ 35CM, 6升食物盆
炉架: 2060F

3060L/2F

ROUND INDUCTION CHAFING DISH
W/ GLASS WINDOWED LID
OPTIONAL Φ 35CM FOOD PAN, 6Ltr
MATCHING STAND 2060F
SPEC./产品尺寸
BODY上装: 50.5X43.5X21.7CM
FRAME下装: 44.5X44.5X18.5CM
MEAS./包装尺寸:
BODY上装: 45.5X41.5X24.5CM
FRAME下装: 45X45X20CM

圆型液压式玻璃盖高级餐炉
配玻璃盖
可配 Φ 35CM, 6升食物盆
炉架: 2060F

2060F

HEAT SOURCE:
INDUCTION COOKER
ELECTRICAL WARMER
炉架可搭配电磁炉, 电热板

OPTIONAL ACCESSORIES:
VITRIFIED NON-POROUS PORCELAIN
FOOD PAN
可使用: 强化瓷食物盆

PRF36/2-2

Φ 33CM ROUND DIVIDED FOOD PAN,
5.8Ltr

PRF36-2

Φ 33CM ROUND FOOD PAN, 6Ltr



30 series hydraulic induction chafing dish

YUFEH
Kitchen Ware

3040/2F

ROUND INDUCTION CHAFING DISH
OPTIONAL Φ 30CM FOOD PAN, 4Ltr
MATCHING STAND 2040F
SPEC./产品尺寸
BODY上装: 43X39X21.8CM
FRAME下装: 37.5X37.5X18.5CM
MEAS./包装尺寸:
BODY上装: 44.5X38X25CM
FRAME下装: 38X38X20CM

圆型液压式钢盖高级餐炉
可配 Φ 30CM, 4升食物盆
炉架: 2040F

3040L/2F

ROUND INDUCTION CHAFING DISH
W/ GLASS WINDOWED LID
OPTIONAL Φ 30CM FOOD PAN, 4Ltr
MATCHING STAND 2040F
SPEC./产品尺寸
BODY上装: 43X39X21.8CM
FRAME下装: 37.5X37.5X18.5CM
MEAS./包装尺寸:
BODY上装: 44.5X38X25CM
FRAME下装: 38X38X20CM

圆型液压式玻璃盖高级餐炉
配玻璃盖
可配 Φ 30CM, 4升食物盆
炉架: 2040F

2040F

HEAT SOURCE:
INDUCTION COOKER
ELECTRICAL WARMER
炉架可搭配电磁炉, 电热板

OPTIONAL ACCESSORIES:
VITRIFIED NON-POROUS PORCELAIN
FOOD PAN
可使用: 强化瓷食物盆

PRF28/2-2

Φ 28CM ROUND DIVIDED FOOD PAN,
3.8Ltr

PRF28-2

Φ 28CM ROUND FOOD PAN, 4Ltr



30 series hydraulic induction chafing dish

30-11/2F

ROUND INDUCTION SOUP STATION
OPTIONAL 11L SOUP BUCKET
MATCHING STAND 20-11F
SPEC./产品尺寸
BODY上装: 45X39.5X34.5CM
FRAME下装: 37.7X37.7X18.5CM
MEAS./包装尺寸:
BODY上装: 46X40.5X37.5CM
FRAME下装: 38X38X20CM

圆型液压式钢盖高级汤炉
可配11升汤桶
炉架: 20-11F

30-11L/2F

ROUND INDUCTION SOUP STATION
W/ GLASS WINDOWED LID
OPTIONAL 11L SOUP BUCKET
MATCHING STAND 20-11F
SPEC./产品尺寸
BODY上装: 45X39.5X34.5CM
FRAME下装: 37.7X37.7X18.5CM
MEAS./包装尺寸:
BODY上装: 46X40.5X37.5CM
FRAME下装: 38X38X20CM

圆型液压式玻璃盖高级汤炉
配玻璃盖
可配11升汤桶
炉架: 20-11F

20-11F

HEAT SOURCE:
INDUCTION COOKER
ELECTRICAL WARMER
炉架可搭配电磁炉, 电热板

11L INSERT SOUP BUCKET
11升汤桶



S3011

FULL SIZE INDUCTION CHAFING DISH
OPTIONAL GN1/1 FOOD PAN, 9Ltr
MATCHING STAND S3011F
SPEC./产品尺寸
BODY上装: 57.5X45.3X21.4CM
FRAME下装: 57.8X37.5X12.5CM
MEAS./包装尺寸:
BODY上装: 58X45.5X25CM
FRAME下装: 58X38X14CM

长方型液压式钢盖高级餐炉
可配GN1/1食物盆, 9升
炉架: S3011F

S3011L

FULL SIZE INDUCTION CHAFING DISH
W/ GLASS WINDOWED LID
OPTIONAL GN1/1 FOOD PAN, 9Ltr
MATCHING STAND S3011F
SPEC./产品尺寸
BODY上装: 57.5X45.3X21.4CM
FRAME下装: 57.8X37.5X12.5CM
MEAS./包装尺寸:
BODY上装: 58X45.5X25CM
FRAME下装: 58X38X14CM

长方型液压式玻璃盖高级餐炉
配玻璃盖
可配GN1/1食物盆, 9升
炉架: S3011F

S3011F

HEAT SOURCE:
INDUCTION COOKER
ELECTRICAL WARMER
炉架可搭配电磁炉, 电热板

STACKABLE FRAME DESIGN

炉架叠式设计, 方便储存

OPTIONAL ACCESSORIES:
VITRIFIED NON-POROUS PORCELAIN
FOOD PAN
可使用: 强化瓷食物盆

P811-2
GN 1/1 FOOD PAN 9Ltr

P812-2
GN 1/2 FOOD PAN 4Ltr

P823-2
GN 2/3 FOOD PAN 6Ltr

P823/2-2
GN 2/3 DIVIDED FOOD PAN 6Ltr

P813-2
GN 1/3 FOOD PAN 2.5Ltr

30 series hydraulic induction
chafing dish

YUFEH
Kitchen Ware

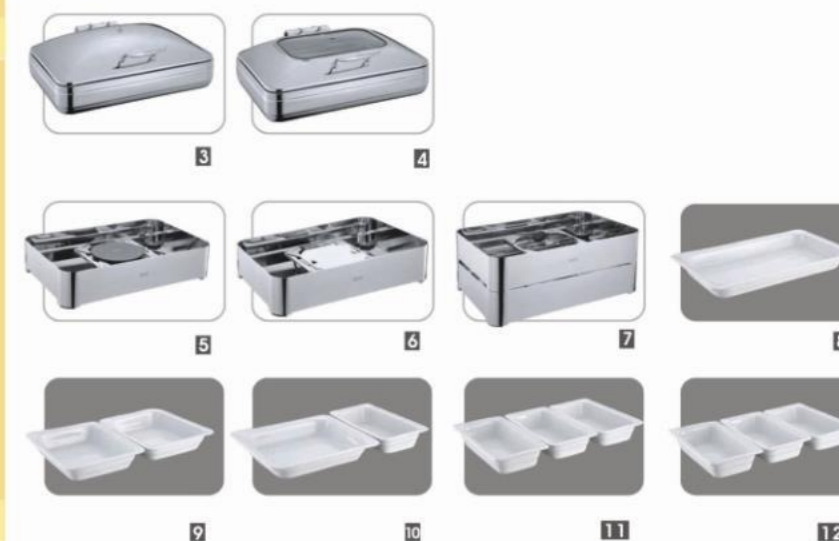

S30 series hydraulic induction chafing dish

S30 series hydraulic induction chafing dish

YUFEH
Kitchen Ware

■ S3032

2/3 SIZE INDUCTION CHAFING DISH
OPTIONAL GN2/3 FOOD PAN, 6Ltr
MATCHING STAND S3032F

SPEC./产品尺寸
BODY上装: 45X40.5X21.5CM
FRAME下装: 40.3X37.8X12.5CM
MEAS./包装尺寸:
BODY上装: 45.5x41.5x24.5cm
FRAME下装: 40.5X38.5X14CM

方型液压式钢盖高级餐炉
可配GN2/3食物盆,6升
炉架: S3032F



1



3

■ S3032L

2/3 SIZE INDUCTION CHAFING DISH
W/ GLASS WINDOWED LID
OPTIONAL GN2/3 FOOD PAN, 6Ltr
MATCHING STAND S3032F

SPEC./产品尺寸
BODY上装: 45X40.5X21.5CM
FRAME下装: 40.3X37.8X12.5CM
MEAS./包装尺寸:
BODY上装: 45.5x41.5x24.5cm
FRAME下装: 40.5X38.5X14CM

方型液压式玻璃盖高级餐炉
配玻璃盖
可配GN2/3食物盆,6升
炉架: S3032F



4



5



6



7



8



9

■ S3032F

HEAT SOURCE:
INDUCTION COOKER
ELECTRICAL WARMER
炉架可搭配电磁炉或电热板

■ STACKABLE FRAME DESIGN

炉架叠式设计, 方便储存

OPTIONAL ACCESSORIES:
VITRIFIED NON-POROUS PORCELAIN
FOOD PAN
可使用: 强化瓷食物盆

■ P823-2

GN 2/3 FOOD PAN 6Ltr

■ P823/2-2

GN 2/3 DIVIDED FOOD PAN 6Ltr



2

■ S3021

HALF SIZE INDUCTION CHAFING DISH
OPTIONAL GN1/2 FOOD PAN, 4Ltr
MATCHING STAND S3021F

SPEC./产品尺寸
BODY上装: 44.7x31.5x21cm
FRAME下装: 37.5X31.5X12.5CM
MEAS./包装尺寸:
BODY上装: 45X32X25.5CM
FRAME下装: 38X32.5X14CM

方型液压式钢盖高级餐炉
可配GN1/2食物盆,4升
炉架: S3021F



1

■ S3021L

HALF SIZE INDUCTION CHAFING DISH
W/ GLASS WINDOWED LID
OPTIONAL GN1/2 FOOD PAN, 4Ltr
MATCHING STAND S3021F

SPEC./产品尺寸
BODY上装: 44.7x31.5x21cm
FRAME下装: 37.5X31.5X12.5CM
MEAS./包装尺寸:
BODY上装: 45X32X25.5CM
FRAME下装: 38X32.5X14CM

方型液压式玻璃盖高级餐炉
配玻璃盖
可配GN1/2食物盆,4升
炉架: S3021F



3



4



5



6



7



8

■ S3021F

HEAT SOURCE:
INDUCTION COOKER
ELECTRICAL WARMER
炉架可搭配电磁炉或电热板

■ STACKABLE FRAME DESIGN

炉架叠式设计, 方便储存

OPTIONAL ACCESSORIES:
VITRIFIED NON-POROUS PORCELAIN
FOOD PAN
可使用: 强化瓷食物盆

■ P812-2

GN 1/2 FOOD PAN 4Ltr



2

S30 series hydraulic induction chafing dish

■ S3060

ROUND INDUCTION CHAFING DISH
OPTIONAL Φ 35CM FOOD PAN, 6Ltr
MATCHING STAND S3060F

SPEC./产品尺寸
BODY上装: 50.5x43.5x21.7CM
FRAME下装: 44.5x44.5x12.5CM
MEAS./包装尺寸:
BODY上装: 45.5x41.5x24.5CM
FRAME下装: 45.5x45.5x14CM

圆型液压式钢盖高级餐炉
可配 Φ 35CM, 6升食物盆
炉架: S3060F

■ S3060L

ROUND INDUCTION CHAFING DISH
W/ GLASS WINDOWED LID
OPTIONAL Φ 35CM FOOD PAN, 6Ltr
MATCHING STAND S3060F

SPEC./产品尺寸
BODY上装: 50.5x43.5x21.7CM
FRAME下装: 44.5x44.5x12.5CM
MEAS./包装尺寸:
BODY上装: 45.5x41.5x24.5CM
FRAME下装: 45.5x45.5x14CM

圆型液压式玻璃盖高级餐炉
配玻璃盖
可配 Φ 35CM, 6升食物盆
炉架: S3060F

■ S3060F

HEAT SOURCE:
INDUCTION COOKER
ELECTRICAL WARMER
炉架可搭配电磁炉或电热板

■ STACKABLE FRAME DESIGN

炉架叠式设计, 方便储存

OPTIONAL ACCESSORIES:
VITRIFIED NON-POROUS PORCELAIN
FOOD PAN
可使用: 强化瓷食物盆

■ PRF36/2-2

Φ 33CM ROUND DIVIDED FOOD PAN,
5.8Ltr

■ PRF36-2

Φ 33CM ROUND FOOD PAN, 6Ltr



1



3



4



5



6



7



8



9



2

S30 series hydraulic induction
chafing dish

YUFEH
Kitchen Ware



1

■ S3040

ROUND INDUCTION CHAFING DISH
OPTIONAL Φ 30CM FOOD PAN, 4Ltr
MATCHING STAND S3040F

SPEC./产品尺寸
BODY上装: 43X39X21.8CM
FRAME下装: 37.5X37.5X12.5M
MEAS./包装尺寸:
BODY上装: 44.5X38X25CM
FRAME下装: 38.5X38.5X14CM

圆型液压式钢盖高级餐炉
可配 Φ 30CM, 4升食物盆
炉架: S3040F

■ S3040L

ROUND INDUCTION CHAFING DISH
W/ GLASS WINDOWED LID
OPTIONAL Φ 30CM FOOD PAN, 4Ltr
MATCHING STAND S3040F

SPEC./产品尺寸
BODY上装: 43X39X21.8CM
FRAME下装: 37.5X37.5X12.5CM
MEAS./包装尺寸:
BODY上装: 44.5X38X25CM
FRAME下装: 38.5X38.5X14CM

圆型液压式玻璃盖高级餐炉
配玻璃盖
可配 Φ 30CM, 4升食物盆
炉架: S3040F

■ S3040F

HEAT SOURCE:
INDUCTION COOKER
ELECTRICAL WARMER
炉架可搭配电磁炉或电热板

■ STACKABLE FRAME DESIGN

炉架叠式设计, 方便储存

OPTIONAL ACCESSORIES:
VITRIFIED NON-POROUS PORCELAIN
FOOD PAN
可使用: 强化瓷食物盆

■ PRF28/2-2

Φ 28CM ROUND DIVIDED FOOD PAN,
3.8Ltr

■ PRF28-2

Φ 28CM ROUND FOOD PAN, 4Ltr



3



4



5



6



7



8



9



2

S30 series hydraulic induction chafing dish

■ S30-11

ROUND INDUCTION SOUP STATION
OPTIONAL 11L SOUP BUCKET
MATCHING STAND S30-11F
SPEC./产品尺寸
BODY上装: 45X39.5X34.5CM
FRAME下装: 37.5X37.5X12.5CM
MEAS./包装尺寸:
BODY上装: 46X40.5X37.5CM
FRAME下装: 38.5X38.5X14CM

圆型液压式钢盖高级汤炉
可配11升汤桶
炉架: S30-11F

■ S30-11L

ROUND INDUCTION SOUP STATION
W/ GLASS WINDOWED LID
OPTIONAL 11L SOUP BUCKET
MATCHING STAND S30-11F
SPEC./产品尺寸
BODY上装: 45X39.5X34.5CM
FRAME下装: 37.5X37.5X12.5CM
MEAS./包装尺寸:
BODY上装: 46X40.5X37.5CM
FRAME下装: 38.5X38.5X14CM

圆型液压式玻璃盖高级汤炉
配玻璃盖
可配11升汤桶
炉架: S30-11F

■ S30-11F

HEAT SOURCE:
INDUCTION COOKER
ELECTRICAL WARMER
炉架可搭配电磁炉或电热板

■ STACKABLE FRAME DESIGN

炉架叠式设计, 方便储存

■ 11L INSERT SOUP BUCKET

11升汤桶



Hydraulic induction chafing dish

YUFEH
Kitchen Ware



■ 30-12P

12L DELUX JUICE DISPENSER
PC BODY
12L 热/冷果汁鼎
桶身: PC料
SPEC./产品尺寸: 33X33X50CM
MEAS./包装尺寸: 34X34X51.5CM

■ 30-12

12L DELUX COFFEE URN
12L 热咖啡鼎
SPEC./产品尺寸: 33X33X50.5CM
MEAS./包装尺寸: 34X34X41.5CM

■ 30-12DW

12L DELUX DOUBLE WALL COFFEE URN
12L 双层热咖啡鼎
SPEC./产品尺寸: 33X33X50.5CM
MEAS./包装尺寸: 34X34X41.5CM

■ 30-19

19L DELUX COFFEE URN
19L 热咖啡鼎
SPEC./产品尺寸: 33X33X52.3CM
MEAS./包装尺寸: 34X34X54CM

■ 30-19DW

19L DELUX DOUBLE WALL COFFEE URN
19L 双层热咖啡鼎
SPEC./产品尺寸: 33X33X52.3CM
MEAS./包装尺寸: 34X34X54CM

■ SINGLE WALL COFFEE URN
(单层热咖啡鼎)
SINGLE WALL
(单层)

■ DOUBLE WALL COFFEE URN
(双层保温咖啡鼎)
PROVIDES INSULATION TO
MAINTAIN COFFEE TEMPERATURE



Hydraulic induction chafing dish



LID POSITION
OPEN UP TO MAXIMUM 90°
STAYS OPEN AT 70°
INITIATE TO CLOSE BY PRESSING DOWN GENTLY
LID FALLS & CLOSSES AUTOMATICALLY & SILENTLY
炉盖开启角度: 90° / 70°

WATER RETURN SYSTEM
CONDENSATION FLOWS BACK TO
WATER PAN INSTEAD OF FOOD PAN
水蒸汽回流系统

HYDRAULIC HINGE
FOR SMOOTH OPENING & CLOSING LID
液压铰链: 保持炉盖开合顺畅宁静

ADJUSTABLE LEVEL SUPPORT
for a perfectly level placement
when required
水平调节: 调整适当支撑高度稳定水盆

INSERT LIFTING PIN
CHANGING FOOD PAN EASILY
顶针: 可快捷更换食物盆

CAPSULED BOTTOM
CAPSULE-SANDWICH INDUCTION
BASE FOR FAST & EVEN HEATING
复合包底



YUFEH's delux induction chafing dish.

- With Elegant design and practical funtion.
- The dish itself can compatible with induction plates or along with matching frame for a more classic buffet environment.
- Heat source like induction plates, electrical warmer and sterno are all suitable.
- The patented hydraulic mechanism gives an extremely smooth lid motion. Gentle & silent opening & closing of lid which helps to define the class of a buffet
- 宇辉最新系列自助餐炉
- 优雅简洁的设计和强大的实用性功能
- 可独立使用于电磁炉或电热板上, 亦可选配炉架, 使用电磁炉或燃料.
- 最新注册设计的液压系统结构, 在使用过程中, 保持炉盖开合顺畅宁静

REMOVABLE COVER
for cleaning and storage
可拆卸式炉盖方便清洗及储存



10 Series hydraulic induction chafing dish

10 Series hydraulic induction chafing dish

YUFEH
Kitchen Ware

1011

FULL SIZE INDUCTION CHAFING DISH
OPTIONAL GN1/1 FOOD PAN, 9Ltr
MATCHING STAND 1011F

SPEC./产品尺寸
BODY上装: 58.5X45.5X21CM
FRAME下装: 51.5X41.5X16.5CM
MEAS./包装尺寸:
BODY上装: 59.5X46X23.5CM
FRAME下装: 52X42X17.5CM

长方型液压式钢盖高级餐炉
可配GN1/1食物盆, 9升
炉架: 1011F



1

1011L

FULL SIZE INDUCTION CHAFING DISH
W/ GLASS WINDOWED LID
OPTIONAL GN1/1 FOOD PAN, 9Ltr
MATCHING STAND 1011F

SPEC./产品尺寸
BODY上装: 58.5X45.5X21CM
FRAME下装: 51.5X41.5X16.5CM
MEAS./包装尺寸:
BODY上装: 59.5X46X23.5CM
FRAME下装: 52X42X17.5CM

长方型液压式玻璃盖高级餐炉
配玻璃盖
可配GN1/1食物盆, 9升
炉架: 1011F

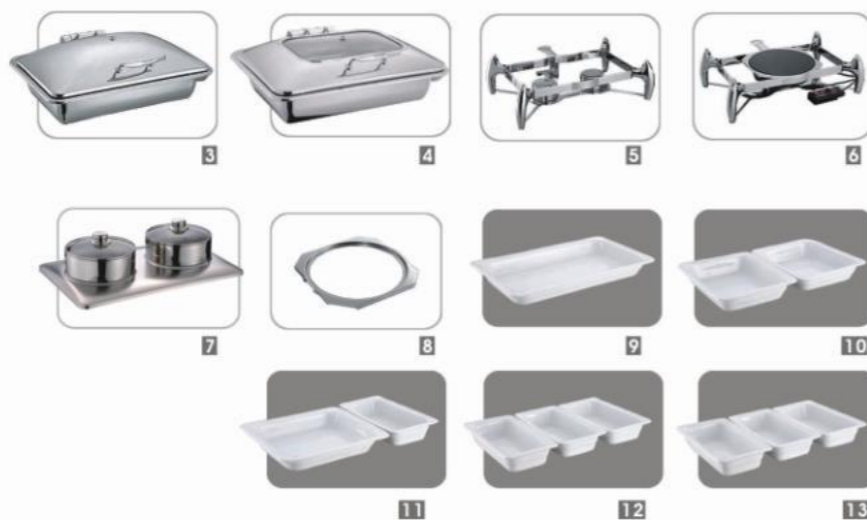

1011F

炉架

HEAT SOURCE:INDUCTION COOKER

炉架可搭配电磁炉

8" STEAMER

8"蒸笼

Y1011P

INDUCTION PLATE
电磁炉固定板

OPTIONAL ACCESSORIES:
VITRIFIED NON-POROUS PORCELAIN
FOOD PAN
可使用: 强化瓷食物盆

P811-2

GN 1/1 FOOD PAN 9Ltr

P812-2

GN 1/2 FOOD PAN 4Ltr

P823-2

GN 2/3 FOOD PAN 6Ltr

P823/2-2

GN 2/3 DIVIDED FOOD PAN 6Ltr

P813-2

GN 1/3 FOOD PAN 2.5Ltr



2

1032

2/3 SIZE INDUCTION CHAFING DISH
OPTIONAL GN2/3 FOOD PAN, 6Ltr
MATCHING STAND 1032F

SPEC./产品尺寸
BODY上装: 45.5X41X21CM
FRAME下装: 41.5X37X16.5CM
MEAS./包装尺寸:
BODY上装: 46X42X22.5CM
FRAME下装: 42X38X18CM

方型液压式钢盖高级餐炉
可配GN2/3食物盆, 6升
炉架: 1032F



1

1032L

2/3 SIZE INDUCTION CHAFING DISH
W/ GLASS WINDOWED LID
OPTIONAL GN2/3 FOOD PAN, 6Ltr
MATCHING STAND 1032F

SPEC./产品尺寸
BODY上装: 45.5X41X21CM
FRAME下装: 41.5X37X16.5CM
MEAS./包装尺寸:
BODY上装: 46X42X22.5CM
FRAME下装: 42X38X18CM

方型液压式玻璃盖高级餐炉
配玻璃盖
可配GN2/3食物盆, 6升
炉架: 1032F



1032F

炉架

HEAT SOURCE:INDUCTION COOKER

炉架可搭配电磁炉

Y1032P

INDUCTION PLATE
电磁炉固定板

OPTIONAL ACCESSORIES:
VITRIFIED NON-POROUS PORCELAIN
FOOD PAN
可使用: 强化瓷食物盆

P823-2

GN 2/3 FOOD PAN 6Ltr

P823/2-2

GN 2/3 DIVIDED FOOD PAN 6Ltr



2

10 Series hydraulic induction chafing dish

10 Series hydraulic induction chafing dish

YUFEH
Kitchen Ware

1021

HALF SIZE INDUCTION CHAFING DISH
OPTIONAL GN1/2 FOOD PAN, 4.0Ltr
MATCHING STAND 1021F

SPEC./产品尺寸

BODY上装: 45.5X32X21CM
FRAME下装: 41.5X29X16CM

MEAS./包装尺寸:

BODY上装: 46X33X23CM
FRAME下装: 42X30X18CM

方型液压式钢盖高级餐炉
可配GN1/2食物盆,4升
炉架: 1021F



1

1021L

HALF SIZE INDUCTION CHAFING DISH
W/ GLASS WINDOWED LID
OPTIONAL GN1/2 FOOD PAN, 4Ltr
MATCHING STAND 1021F

SPEC./产品尺寸

BODY上装: 45.5X32X21CM
FRAME下装: 41.5X29X16CM

MEAS./包装尺寸:

BODY上装: 46X33X23CM
FRAME下装: 42X30X18CM

方型液压式玻璃盖高级餐炉
配玻璃盖
可配GN1/2食物盆,4升
炉架: 1021F



3

4

5

6

7

8



2

1060

ROUND INDUCTION CHAFING DISH
OPTIONAL Φ35CM FOOD PAN, 6.0Ltr
MATCHING STAND 1060F

SPEC./产品尺寸

BODY上装: 52X45.5X21CM
FRAME下装: 43X31X16.5CM

MEAS./包装尺寸:

BODY上装: 52.5X46X22.5CM
FRAME下装: 43.5X33X18CM

圆型液压式钢盖高级餐炉
可配Φ35CM,6升食物盆
炉架: 1060F



1



3

4

5

6

7

8

9

10

1060L

ROUND INDUCTION CHAFING DISH
W/ GLASS WINDOWED LID
OPTIONAL Φ35CM FOOD PAN, 6.0Ltr
MATCHING STAND 1060F

SPEC./产品尺寸

BODY上装: 52X45.5X21CM
FRAME下装: 43X31X16.5CM

MEAS./包装尺寸:

BODY上装: 52.5X46X22.5CM
FRAME下装: 43.5X33X18CM

圆型液压式玻璃盖高级餐炉
配玻璃盖
可配Φ35CM,6升食物盆
炉架: 1060F

1060F

炉架

HEAT SOURCE:INDUCTION COOKER

炉架可搭配电磁炉

Y1060P

INDUCTION PLATE
电磁炉固定板

10" STEAMER

10"蒸笼

OPTIONAL ACCESSORIES:
VITRIFIED NON-POROUS PORCELAIN
FOOD PAN
可使用: 强化瓷食物盆

PRF36/2-2

Φ33CM ROUND DIVIDED FOOD PAN,
5.8Ltr

PRF36-2

Φ33CM ROUND FOOD PAN, 6Ltr



2

10 Series hydraulic induction chafing dish

10 Series hydraulic induction chafing dish

YUFEH
Kitchen Ware

1040

ROUND INDUCTION CHAFING DISH
OPTIONAL Φ 30CM FOOD PAN, 4Ltr
MATCHING STAND 1040F
SPEC./产品尺寸
BODY 上装: 47x39x21CM
FRAME 下装: 38.5x27.5x16.5CM
MEAS./包装尺寸:
BODY 上装: 47.5X39.5X22.5CM
FRAME 下装: 39X28X17.5CM

圆型液压式钢盖高级餐炉
可配 Φ 30CM, 4升食物盆
炉架: 1040F



1040L

ROUND INDUCTION CHAFING DISH
W/ GLASS WINDOWED LID
OPTIONAL 30CM FOOD PAN, 4.0Ltr
MATCHING STAND 1040F
SPEC./产品尺寸
BODY 上装: 47x39x21CM
FRAME 下装: 38.5x27.5x16.5CM
MEAS./包装尺寸:
BODY 上装: 47.5X39.5X22.5CM
FRAME 下装: 39X28X17.5CM

圆型液压式玻璃盖高级餐炉
配玻璃盖
可配 Φ 30CM, 4升食物盆
炉架: 1040F



1040F

HEAT SOURCE: INDUCTION COOKER
炉架可搭配电磁炉

Y1040P

INDUCTION PLATE
电磁炉固定板

OPTIONAL ACCESSORIES:
VITRIFIED NON-POROUS PORCELAIN
FOOD PAN
可使用: 强化瓷食物盆

PRF28/2-2

Φ 28CM ROUND DIVIDED FOOD PAN,
3.8Ltr

PRF28-2

Φ 28CM ROUND FOOD PAN, 4Ltr



1050

FAN-SHAPED INDUCTION CHAFING DISH
OPTIONAL 5L FAN-SHAPED FOOD PAN
MATCHING STAND 1050F
SPEC./产品尺寸: 53X38.5X32.5CM
MEAS./包装尺寸:
BODY 上装: 54X39.5X22.5CM
FRAME 下装: 52X32X17.5CM

扇型液压式钢盖高级餐炉
可配5L扇型物盆
炉架: 1050F



1080

FAN-SHAPED INDUCTION CHAFING DISH
OPTIONAL 8L FAN-SHAPED FOOD PAN
MATCHING STAND 1080F
SPEC./产品尺寸: 61.5X42.5X32.5CM
MEAS./包装尺寸:
BODY 上装: 62.5X43.5X22.5CM
FRAME 下装: 61X35.5X17.5CM

扇型液压式钢盖高级餐炉
可配8L扇型物盆
炉架: 1080F



10 Series hydraulic induction chafing dish

SS10 Series hydraulic induction chafing dish

YUFEH
Kitchen Ware

10-11

ROUND INDUCTION SOUP STATION
OPTIONAL 11L SOUP BUCKET
MATCHING STAND 10-11F
SPEC./产品尺寸
BODY上装: 49.5X47X32.5CM
FRAME下装: 43X31X16.5CM
MEAS./包装尺寸:
BODY上装: 44X44X33CM
FRAME下装: 43.5X33X18CM

圆型液压式钢盖高级汤炉
可配11升汤桶
炉架: 10-11F

10-11L

ROUND INDUCTION SOUP STATION
W/ GLASS WINDOWED LID
OPTIONAL 11L SOUP BUCKET
MATCHING STAND 10-11F
SPEC./产品尺寸
BODY上装: 49.5X47X32.5CM
FRAME下装: 43X31X16.5CM
MEAS./包装尺寸:
BODY上装: 44X44X33CM
FRAME下装: 43.5X33X18CM

圆型液压式玻璃盖高级汤炉
配玻璃盖
可配11升汤桶
炉架: 10-11F

10-11F

炉架

HEAT SOURCE:INDUCTION COOKER

炉架可搭配电磁炉

Y1060P

INDUCTION PLATE
电磁炉固定板

SPOON HOLDER

汤梗兜

11L INSERT SOUP BUCKET

11升汤桶



1



3



5



4



6



7



8



9



2

SS1011

FULL SIZE INDUCTION CHAFING DISH
OPTIONAL GN1/1 FOOD PAN, 9Ltr
MATCHING STAND SS1011F
SPEC./产品尺寸: 58.5X45.5X29CM
MEAS./包装尺寸: 59.5X46X30CM
长方型液压式高级餐炉
可配GN1/1食物盆, 9升
炉架: SS1011F

SS1011L

FULL SIZE INDUCTION CHAFING DISH
W/ GLASS WINDOWED LID
OPTIONAL GN1/1 FOOD PAN, 9Ltr
MATCHING STAND SS1011F
SPEC./产品尺寸: 58.5X45.5X29CM
MEAS./包装尺寸: 59.5X46X30CM
长方型液压式玻璃盖高级餐炉
配玻璃盖
可配GN1/1食物盆, 9升
炉架: SS1011F

SS1032

2/3 SIZE INDUCTION CHAFING DISH
OPTIONAL GN2/3 FOOD PAN, 6Ltr
MATCHING STAND SS1032F
SPEC./产品尺寸: 45.5X41X29CM
MEAS./包装尺寸: 46X42X30CM
方型液压式高级餐炉
可配GN2/3食物盆, 6升
炉架: SS1032F

SS1032L

2/3 SIZE INDUCTION CHAFING DISH
W/ GLASS WINDOWED LID
OPTIONAL GN2/3 FOOD PAN, 6Ltr
MATCHING STAND SS1032F
SPEC./产品尺寸: 45.5X41X29CM
MEAS./包装尺寸: 46X42X30CM
方型液压式玻璃盖高级餐炉
配玻璃盖
可配GN2/3食物盆, 6升
炉架: SS1032F

SS1011F

炉架

HEAT SOURCE OPTION:

INDUCTION COOKER
ELECTRICAL WARMER
可自由搭配电磁炉或电热板



5



6



7



1



2



3



4

SS10 Series hydraulic induction chafing dish

SS10 Series hydraulic induction chafing dish

YUFEH
Kitchen Ware



1

SS1021

HALF SIZE INDUCTION CHAFING DISH
OPTIONAL GN1/2 FOOD PAN, 4.0Ltr
MATCHING STAND SS1021F
SPEC./产品尺寸:45.5X32X29.5CM
MEAS./包装尺寸:46X33X31CM

方型液压式高级餐炉
可配GN1/2食物盆,4升
炉架: SS1021F



3

SS1021L

HALF SIZE INDUCTION CHAFING DISH
W/ GLASS WINDOWED LID
OPTIONAL GN1/2 FOOD PAN, 4.0Ltr
MATCHING STAND SS1021F
SPEC./产品尺寸:45.5X41X34CM
MEAS./包装尺寸:46X33X31CM

方型液压式玻璃盖高级餐炉
配玻璃盖
可配GN1/2食物盆,4升
炉架: SS1021F



2

SS1021F

炉架

SS1060

ROUND INDUCTION CHAFING DISH
OPTIONAL Φ 35CM FOOD PAN, 6.0Ltr
MATCHING STAND SS1060F
SPEC./产品尺寸:52X45.5X29CM
MEAS./包装尺寸:52.5X46X30CM

圆型液压式高级餐炉
可配 Φ 35CM,6升食物盆
炉架: SS1060F



1

SS1060L

ROUND INDUCTION CHAFING DISH
W/ GLASS WINDOWED LID
OPTIONAL Φ 35CM FOOD PAN, 6.0Ltr
MATCHING STAND SS1060F
SPEC./产品尺寸:52X45.5X29CM
MEAS./包装尺寸:52.5X46X30CM

圆型液压式玻璃盖高级餐炉
配玻璃盖
可配 Φ 35CM,6升食物盆
炉架: SS1060F

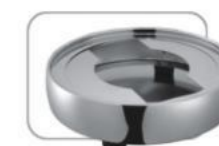

3

SS1060F

炉架



2

SS10 Series hydraulic induction chafing dish

SS10 Series hydraulic induction chafing dish

YUFEH
Kitchen Ware



1

SS1040

ROUND INDUCTION CHAFING DISH
OPTIONAL Φ 30CM FOOD PAN, 4Ltr
MATCHING STAND SS1040F
SPEC./产品尺寸: 47x39x29CM
MEAS./包装尺寸: 38.5x27.5x30CM

圆型液压式钢盖高级餐炉
可配 Φ 30CM, 4升食物盆
炉架: SS1040F



3

SS1040L

ROUND INDUCTION CHAFING DISH
W/ GLASS WINDOWED LID
OPTIONAL Φ 30CM FOOD PAN, 4Ltr
MATCHING STAND SS1040F
SPEC./产品尺寸: 47x39x29CM
MEAS./包装尺寸: 38.5x27.5x30CM

圆型液压式玻璃盖高级餐炉
配玻璃盖
可配 Φ 30CM, 4升食物盆
炉架: SS1040F

SS1040F

HEAT SOURCE: INDUCTION COOKER,
ELECTRICAL WARMER
可自由搭配电磁炉或电热板

STACKABLE FRAME DESIGN
炉架叠式设计, 方便储存



2

SS10-11

ROUND INDUCTION SOUP STATION
OPTIONAL 11L SOUP BUCKET
MATCHING STAND SS10-11F
SPEC./产品尺寸: 49.5x47x41.5CM
MEAS./包装尺寸: 44x44x43CM
圆型液压式高级汤炉
可配11升汤桶
炉架: SS10-11F

SS10-11L

ROUND INDUCTION SOUP STATION
W/ GLASS WINDOWED LID
OPTIONAL 11L SOUP BUCKET
MATCHING STAND SS10-11F
SPEC./产品尺寸: 49.5x47x41.50CM
MEAS./包装尺寸: 44x44x43CM
圆型液压式玻璃盖高级餐炉
配玻璃盖
可配11升汤桶
炉架: SS10-11F

SS10-11F

炉架

11L INSERT SOUP BUCKET

11升汤桶



1



3

4



2

S10 Series hydraulic induction chafing dish



S1011

FULL SIZE INDUCTION CHAFING DISH
OPTIONAL GN1/1 FOOD PAN, 9Ltr
MATCHING STAND S1011F
SPEC./产品尺寸: 60X47X29.5CM
MEAS./包装尺寸: 61X48X31.5

长方型液压式高级餐炉
可配GN1/1食物盆, 9升

S1011L

FULL SIZE INDUCTION CHAFING DISH
W/ GLASS WINDOWED LID
OPTIONAL GN1/1 FOOD PAN, 9Ltr
MATCHING STAND S1011F
SPEC./产品尺寸: 60X47X29.5CM
MEAS./包装尺寸: 61X48X31.5

长方型液压式玻璃盖高级餐炉
配玻璃盖
可配GN1/1食物盆, 9升

S1032

2/3 SIZE INDUCTION CHAFING DISH
OPTIONAL GN2/3 FOOD PAN, 6Ltr
MATCHING STAND S1032F
SPEC./产品尺寸: 47X44X30CM
MEAS./包装尺寸: 48X45X32CM

方型液压式高级餐炉
可配GN2/3食物盆, 6升

S1032L

2/3 SIZE INDUCTION CHAFING DISH
W/ GLASS WINDOWED LID
OPTIONAL GN2/3 FOOD PAN, 6Ltr
MATCHING STAND S1032F
SPEC./产品尺寸: 47X44X30CM
MEAS./包装尺寸: 48X45X32CM

方型液压式玻璃盖高级餐炉
配玻璃盖
可配GN2/3食物盆, 6升

A1011P

INDUCTION PLATE
电磁炉固定板

FRAME

脚架



S1060

ROUND INDUCTION CHAFING DISH
OPTIONAL Φ 35CM FOOD PAN, 6.0Ltr
MATCHING STAND S1060F
SPEC./产品尺寸: 47X54X29CM
MEAS./包装尺寸: 48X55X31CM

圆型液压式高级餐炉
可配 Φ 35CM, 6升食物盆

S1060L

ROUND INDUCTION CHAFING DISH
W/ GLASS WINDOWED LID
OPTIONAL Φ 35CM FOOD PAN, 6.0Ltr
MATCHING STAND S1060F
SPEC./产品尺寸: 47X54X29CM
MEAS./包装尺寸: 48X55X31CM

圆型液压式玻璃盖高级餐炉
配玻璃盖
可配 Φ 35CM, 6升食物盆

S1021

HALF SIZE INDUCTION CHAFING DISH
OPTIONAL GN1/2 FOOD PAN, 4.0Ltr
MATCHING STAND S1021F
SPEC./产品尺寸: 47X34X29.5CM
MEAS./包装尺寸: 48X35X31.5CM

方型液压式高级餐炉
可配GN1/2食物盆, 4升

S1021L

HALF SIZE INDUCTION CHAFING DISH
W/ GLASS WINDOWED LID
OPTIONAL GN1/2 FOOD PAN, 4.0Ltr
MATCHING STAND S1021F
SPEC./产品尺寸: 47X34X29.5CM
MEAS./包装尺寸: 48X35X31.5CM

方型液压式玻璃盖高级餐炉
配玻璃盖
可配GN1/2食物盆, 4升



SB10 series hydraulic induction chafing dish

SB10 series hydraulic induction chafing dish

YUFEH
Kitchen Ware

SB1011

FULL SIZE INDUCTION CHAFING DISH
OPTIONAL GN1/1 FOOD PAN, 9Ltr
MATCHING STAND SB1011F
SPEC./产品尺寸: 58.5X46X24.5CM
MEAS./包装尺寸: 59.5X47X27CM

长方形液压式钢盖高级餐炉
可配GN1/1食物盆, 9升
炉架: SB1011F

SB1011L

FULL SIZE INDUCTION CHAFING DISH
W/ GLASS WINDOWED LID
OPTIONAL GN1/1 FOOD PAN, 9Ltr
MATCHING STAND SB1011F
SPEC./产品尺寸: 58.5X46X24.5CM
MEAS./包装尺寸: 59.5X47X27CM

长方形液压式玻璃盖高级餐炉
配玻璃盖
可配GN1/1食物盆, 9升
炉架: SB1011F

STACKABLE FRAME DESIGN

炉架叠式设计, 方便储存

SB1011F

HEAT SOURCE: ELECTRICAL WARMER
炉架可使用电热板

8" STEAMER

8"蒸笼

OPTIONAL ACCESSORIES:
VITRIFIED NON-POROUS PORCELAIN
FOOD PAN
可使用: 强化瓷食物盆

P811-2

GN 1/1 FOOD PAN 9Ltr

P812-2

GN 1/2 FOOD PAN 4Ltr

P823-2

GN 2/3 FOOD PAN 6Ltr

P823/2-2

GN 2/3 DIVIDED FOOD PAN 6Ltr

P813-2

GN 1/3 FOOD PAN 2.5Ltr



1



3

4

5

6

7

8

9

10



2



1



3



4



5



6

SB1032

2/3 SIZE INDUCTION CHAFING DISH
OPTIONAL GN2/3 FOOD PAN, 6Ltr
MATCHING STAND SB1032F
SPEC./产品尺寸: 46.5X41X24.5CM
MEAS./包装尺寸: 47.5X42X27CM

方形液压式钢盖高级餐炉
可配GN2/3食物盆, 6升
炉架: SB1032F

SB1032L

2/3 SIZE INDUCTION CHAFING DISH
W/ GLASS WINDOWED LID
OPTIONAL GN2/3 FOOD PAN, 6Ltr
MATCHING STAND SB1032F
SPEC./产品尺寸: 46.5X41X24.5CM
MEAS./包装尺寸: 47.5X42X27CM

方形液压式玻璃盖高级餐炉
配玻璃盖
可配GN2/3食物盆, 6升
炉架: SB1032F

SB1032F

HEAT SOURCE: ELECTRICAL WARMER
炉架可使用电热板

STACKABLE FRAME DESIGN

炉架叠式设计, 方便储存

OPTIONAL ACCESSORIES:
VITRIFIED NON-POROUS PORCELAIN
FOOD PAN
可使用: 强化瓷食物盆

P823-2

GN 2/3 FOOD PAN 6Ltr

P823/2-2

GN 2/3 DIVIDED FOOD PAN 6Ltr



2

SB10 series hydraulic induction chafing dish

SB10 series hydraulic induction chafing dish

YUFEH
Kitchen Ware

SB1021

HALF SIZE INDUCTION CHAFING DISH
OPTIONAL GN1/2 FOOD PAN, 4Ltr
MATCHING STAND SB1021F
SPEC./产品尺寸: 45.5X32.5X24.5CM
MEAS./包装尺寸: 46.5X33.5X27CM

方型液压式钢盖高级餐炉
可配GN1/2食物盆, 4升
炉架: SB1021F

SB1021L

HALF SIZE INDUCTION CHAFING DISH
W/ GLASS WINDOWED LID
OPTIONAL GN1/2 FOOD PAN, 4Ltr
MATCHING STAND SB1021F
SPEC./产品尺寸: 45.5X32.5X24.5CM
MEAS./包装尺寸: 46.5X33.5X27CM

方型液压式玻璃盖高级餐炉
配玻璃盖
可配GN1/2食物盆, 4升
炉架: SB1021F

SB1021F

HEAT SOURCE: ELECTRICAL WARMER
炉架可使用电热板

STACKABLE FRAME DESIGN

炉架叠式设计, 方便储存

OPTIONAL ACCESSORIES:
VITRIFIED NON-POROUS PORCELAIN
FOOD PAN
可使用: 强化瓷食物盆

P812-2

GN 1/2 FOOD PAN 4Ltr



1



3

4



5



2

SB1060

ROUND INDUCTION CHAFING DISH
OPTIONAL Φ 35CM FOOD PAN, 6Ltr
MATCHING STAND SB1060F
SPEC./产品尺寸: 52.5X45X24.5CM
MEAS./包装尺寸: 53.5X46X27CM

圆型液压式钢盖高级餐炉
可配 Φ 35CM, 6升食物盆
炉架: SB1060F

SB1060L

ROUND INDUCTION CHAFING DISH
W/ GLASS WINDOWED LID
OPTIONAL Φ 35CM FOOD PAN, 6Ltr
MATCHING STAND SB1060F
SPEC./产品尺寸: 52.5X45X24.5CM
MEAS./包装尺寸: 53.5X46X27CM

圆型液压式玻璃盖高级餐炉
配玻璃盖
可配 Φ 35CM, 6升食物盆
炉架: SB1060F

10" STEAMER

10"蒸笼

SB1060F

HEAT SOURCE: ELECTRICAL WARMER
炉架可使用电热板

STACKABLE FRAME DESIGN

炉架叠式设计, 方便储存

OPTIONAL ACCESSORIES:
VITRIFIED NON-POROUS PORCELAIN
FOOD PAN
可使用: 强化瓷食物盆

PRF36/2-2

Φ 33CM ROUND DIVIDED FOOD PAN,
5.8Ltr

PRF36-2

Φ 33CM ROUND FOOD PAN, 6Ltr



1



3



4



5



6



7



2

SB10 series hydraulic induction chafing dish

SB1040

ROUND INDUCTION CHAFING DISH
OPTIONAL Φ 30CM FOOD PAN, 4Ltr
MATCHING STAND SB1040F
SPEC./产品尺寸: 47X39X24.5CM
MEAS./包装尺寸: 48X40X27CM

圆型液压式钢盖高级餐炉
可配 Φ 30CM, 4升食物盆
炉架: SB1040F

SB1040L

ROUND INDUCTION CHAFING DISH
W/ GLASS WINDOWED LID
OPTIONAL 30CM FOOD PAN, 4.0Ltr
MATCHING STAND SB1040F
SPEC./产品尺寸: 47X39X24.5CM
MEAS./包装尺寸: 48X40X27CM

圆型液压式玻璃盖高级餐炉
配玻璃盖
可配 Φ 30CM, 4升食物盆
炉架: SB1040F

SB1040F

HEAT SOURCE: ELECTRICAL WARMER
炉架可使用电热板

STACKABLE FRAME DESIGN

炉架叠式设计, 方便储存

OPTIONAL ACCESSORIES:
VITRIFIED NON-POROUS PORCELAIN
FOOD PAN
可使用: 强化瓷食物盆

PRF28/2-2

Φ 28CM ROUND DIVIDED FOOD PAN,
3.8Ltr

PRF28-2

Φ 28CM ROUND FOOD PAN, 4Ltr



Mechanical hinge induction
chafing dish

YUFEH
Kitchen Ware

Mechanical hinge induction chafing dish

Mechanical hinge induction chafing dish

YUFEH
Kitchen Ware



YUFEH's delux induction chafing dish.

- With Elegant design and practical funtion.
- The dish itself can compatible with induction plates or along with matching frame for a more classic buffet environment.
- Heat source like induction plates, electrical warmer and sterno are all suitable.
- The patented mechanical mechanism gives an extremely smooth lid motion. Gentle & silent opening & closing of lid which helps to define the class of a buffet
- 宇辉最新系列自助餐炉
- 优雅简洁的设计和强大的实用性功能
- 可独立使用于电磁炉或电热板上, 亦可选配炉架, 使用电磁炉或燃料.
- 最新注册设计的机械缓冲式系统结构, 在使用过程中, 保持炉盖开合顺畅宁静



YUFEH's delux induction chafing dish.

炉架可搭配电磁炉

1011B

FULL SIZE MECHANICAL HINGE
INDUCTION CHAFING DISH
OPTIONAL GN1/1 FOOD PAN,9Ltr
MATCHING STAND 1011F
SPEC./产品尺寸
BODY上装: 58.5X45.5X21CM
FRAME 下装: 51.5X41.5X16.5CM
MEAS./包装尺寸:
BODY上装: 59.5X46X23.5CM
FRAME 下装: 52X42X17.5CM
长方型机械缓冲式钢盖高级餐炉
可配GN1/1食物盆,9升

1011LB

FULL SIZE MECHANICAL HINGE
INDUCTION CHAFING DISH
W/ GLASS WINDOWED LID
OPTIONAL GN1/1 FOOD PAN,9Ltr
MATCHING STAND 1011F
SPEC./产品尺寸
BODY上装: 58.5X45.5X21CM
FRAME 下装: 51.5X41.5X16.5CM
MEAS./包装尺寸:
BODY上装: 59.5X46X23.5CM
FRAME 下装: 52X42X17.5CM
长方型机械缓冲式玻璃盖高级餐炉
配玻璃盖
可配GN1/1食物盆,9升
炉架: 1011F

1011F

炉架

HEAT SOURCE:INDUCTION COOKER

炉架可搭配电磁炉

Y1011P

INDUCTION PLATE
电磁炉固定板

8" STEAMER

8"蒸笼

OPTIONAL ACCESSORIES:
VITRIFIED NON-POROUS PORCELAIN
FOOD PAN
可使用: 强化瓷食物盆

P811-2

GN 1/1 FOOD PAN 9Ltr

P812-2

GN 1/2 FOOD PAN 4Ltr

P823-2

GN 2/3 FOOD PAN 6Ltr

P823/2-2

GN 2/3 DIVIDED FOOD PAN 6Ltr

P813-2

GN 1/3 FOOD PAN 2.5Ltr



Mechanical hinge induction chafing dish

Mechanical hinge induction chafing dish

YUFEH
Kitchen Ware

1032B

2/3 SIZE MECHANICAL HINGE INDUCTION CHAFING DISH
OPTIONAL GN2/3 FOOD PAN, 6Ltr
MATCHING STAND 1032F

SPEC./产品尺寸
BODY上装: 45.5X41X21CM
FRAME下装: 41.5X37X16.5CM
MEAS./包装尺寸:
BODY上装: 46X42X22.5CM
FRAME下装: 42X38X18CM

方型机械缓冲式钢盖高级餐炉
可配GN2/3食物盆,6升
炉架: 1032F



1

1032LB

2/3 SIZE MECHANICAL HINGE INDUCTION CHAFING DISH
W/ GLASS WINDOWED LID
OPTIONAL GN2/3 FOOD PAN, 6Ltr
MATCHING STAND 1032F

SPEC./产品尺寸
BODY上装: 45.5X41X21CM
FRAME下装: 41.5X37X16.5CM
MEAS./包装尺寸:
BODY上装: 46X42X22.5CM
FRAME下装: 42X38X18CM

方型机械缓冲式玻璃盖高级餐炉
配玻璃盖
可配GN2/3食物盆,6升
炉架: 1032F



1032F

炉架

HEAT SOURCE:INDUCTION COOKER

炉架可搭配电磁炉

Y1032P

INDUCTION PLATE
电磁炉固定板

OPTIONAL ACCESSORIES:
VITRIFIED NON-POROUS PORCELAIN
FOOD PAN
可使用: 强化瓷食物盆

P823-2

GN 2/3 FOOD PAN 6Ltr

P823/2-2

GN 2/3 DIVIDED FOOD PAN 6Ltr



2

1021B

HALF SIZE MECHANICAL HINGE INDUCTION CHAFING DISH
OPTIONAL GN1/2 FOOD PAN, 4Ltr
MATCHING STAND 1021F

SPEC./产品尺寸
BODY上装: 45.5x32x21CM
FRAME下装: 41.5x29x16.5CM
MEAS./包装尺寸:
BODY上装: 46X33X23CM
FRAME下装: 42X30X18CM

方型机械缓冲式钢盖高级餐炉
可配GN1/2食物盆,4升
炉架: 1021F



1

1021LB

HALF SIZE MECHANICAL HINGE INDUCTION CHAFING DISH
W/ GLASS WINDOWED LID
OPTIONAL GN1/2 FOOD PAN, 4Ltr
MATCHING STAND 1021F

SPEC./产品尺寸
BODY上装: 45.5x32x21CM
FRAME下装: 41.5x29x16.5CM
MEAS./包装尺寸:
BODY上装: 46X33X23CM
FRAME下装: 42X30X18CM

方型机械缓冲式玻璃盖高级餐炉
配玻璃盖
可配GN1/2食物盆,4升
炉架: 1021F



HEAT SOURCE:INDUCTION COOKER

炉架可搭配电磁炉

1021F

炉架

Y1021P

电磁炉固定板

OPTIONAL ACCESSORIES:
VITRIFIED NON-POROUS PORCELAIN
FOOD PAN
可使用: 强化瓷食物盆

P812-2

GN 1/2 FOOD PAN 4Ltr



2

Mechanical hinge induction chafing dish

Mechanical hinge induction chafing dish

YUFEH
Kitchen Ware

1060B

ROUND MECHANICAL HINGE
INDUCTION CHAFING DISH
OPTIONAL Φ 35CM FOOD PAN, 6.0Ltr
MATCHING STAND 1060F

SPEC./产品尺寸

BODY上装: 52x45.5x21CM

FRAME下装: 43x31x16.5CM

MEAS./包装尺寸:

BODY上装: 52.5X46X22.5CM

FRAME下装: 43.5X33X18CM

圆型机械缓冲式钢盖高级餐炉
可配 Φ 35CM,6升食物盆
炉架: 1060F



1060LB

ROUND MECHANICAL HINGE
INDUCTION CHAFING DISH
W/ GLASS WINDOWED LID
OPTIONAL Φ 35CM FOOD PAN, 6.0Ltr
MATCHING STAND 1060F

SPEC./产品尺寸

BODY上装: 52x45.5x21CM

FRAME下装: 43x31x16.5CM

MEAS./包装尺寸:

BODY上装: 52.5X46X22.5CM

FRAME下装: 43.5X33X18CM

圆型机械缓冲式玻璃盖高级餐炉
配玻璃盖
可配 Φ 35CM,6升食物盆
炉架: 1060F

HEAT SOURCE:INDUCTION COOKER

炉架可搭配电磁炉

1060F

炉架

Y1060P

电磁炉固定板

OPTIONAL ACCESSORIES:
VITRIFIED NON-POROUS PORCELAIN
FOOD PAN
可使用: 强化瓷食物盆

PRF36/2-2

Φ 33CM ROUND DIVIDED FOOD PAN,
5.8Ltr

PRF36-2

Φ 33CM ROUND FOOD PAN, 6Ltr

10" STEAMER

10"蒸笼



1040B

ROUND MECHANICAL HINGE
INDUCTION CHAFING DISH
OPTIONAL Φ 30CM FOOD PAN, 4.0Ltr
MATCHING STAND 1040F

SPEC./产品尺寸

BODY上装: 47x39x21CM

FRAME下装: 38.5x27.5x16.5CM

MEAS./包装尺寸:

BODY上装: 47.5X39.5X22.5CM

FRAME下装: 39X28X17.5CM

圆型机械缓冲式钢盖高级餐炉
可配 Φ 30CM,4升食物盆
炉架: 1040F



1040LB

ROUND MECHANICAL HINGE
INDUCTION CHAFING DISH
W/ GLASS WINDOWED LID
OPTIONAL Φ 30CM FOOD PAN, 4.0Ltr
MATCHING STAND 1040F

SPEC./产品尺寸

BODY上装: 47x39x21CM

FRAME下装: 38.5x27.5x16.5CM

MEAS./包装尺寸:

BODY上装: 47.5X39.5X22.5CM

FRAME下装: 39X28X17.5CM

圆型机械缓冲式玻璃盖高级餐炉
配玻璃盖
可配 Φ 30CM,4升食物盆
炉架: 1040F

1040F

HEAT SOURCE: INDUCTION COOKER
炉架可搭配电磁炉

Y1040P

INDUCTION PLATE
电磁炉固定板

OPTIONAL ACCESSORIES:
VITRIFIED NON-POROUS PORCELAIN
FOOD PAN
可使用: 强化瓷食物盆

PRF28/2-2

Φ 28CM ROUND DIVIDED FOOD PAN,
3.8Ltr

PRF28-2

Φ 28CM ROUND FOOD PAN, 4Ltr



Mechanical hinge induction chafing dish

Mechanical hinge induction chafing dish

YUFEH
Kitchen Ware

10-11B

ROUND MECHANICAL HINGE INDUCTION SOUP STATION
OPTIONAL 11L SOUP BUCKET
MATCHING STAND 10-11F

SPEC./产品尺寸
BODY上装: 49.5x47x32.5CM
FRAME下装: 43x31x16.5CM
MEAS./包装尺寸:
BODY上装: 44X44X33CM
FRAME下装: 43.5X33X18CM

圆型机械缓冲式钢盖高级汤炉
可配11升汤桶
炉架: 10-11F



1

10-11LB

ROUND MECHANICAL HINGE INDUCTION SOUP STATION
W/ GLASS WINDOWED LID
OPTIONAL 11L SOUP BUCKET
MATCHING STAND 10-11F

SPEC./产品尺寸
BODY上装: 49.5x47x32.5CM
FRAME下装: 43x31x16.5CM
MEAS./包装尺寸:
BODY上装: 44X44X33CM
FRAME下装: 43.5X33X18CM

圆型机械缓冲式玻璃盖高级汤炉
配玻璃盖
可配11升汤桶
炉架: 10-11F



3

4

5

6

7

8

9

10-11F

炉架

HEAT SOURCE:INDUCTION COOKER

炉架可搭配电磁炉

Y1060P

电磁炉固定板

SPOON HOLDER

汤梗兜

11L INSERT SOUP BUCKET

11升汤桶



2



1



3

4

5

SS1011B

FULL SIZE MECHANICAL HINGE INDUCTION CHAFING DISH
OPTIONAL GN1/1 FOOD PAN,9Ltr
MATCHING STAND SS1011F
SPEC./产品尺寸:58.5X45.5X29CM
MEAS./包装尺寸: 59.5X46X30CM

长方型机械缓冲式高级餐炉
可配GN1/1食物盆,9升
炉架: SS1011F

SS1011LB

FULL SIZE MECHANICAL HINGE INDUCTION CHAFING DISH
W/ GLASS WINDOWED LID
OPTIONAL GN1/1 FOOD PAN,9Ltr
MATCHING STAND SS1011F
SPEC./产品尺寸:58.5X45.5X29CM
MEAS./包装尺寸: 59.5X46X30CM

长方型机械缓冲式玻璃盖高级餐炉
配玻璃盖
可配GN1/1食物盆,9升
炉架: SS1011F

SS1011F

炉架

HEAT SOURCE OPTION:

INDUCTIONCOOKER/
ELECTRICAL WARMER
可自由搭配电磁炉或电热板



2

Mechanical hinge induction chafing dish

Mechanical hinge induction chafing dish

YUFEH
Kitchen Ware

■ SS1032B

2/3 SIZE MECHANICAL HINGE INDUCTION CHAFING DISH
OPTIONAL GN2/3 FOOD PAN, 6Ltr
MATCHING STAND SS1032F
SPEC./产品尺寸:45.5X41X29CM
MEAS./包装尺寸: 46X42X30CM

方型机械缓冲式高级餐炉
可配GN2/3食物盆,6升
炉架: SS1032F



1



1



3

■ SS1032LB

2/3 SIZE MECHANICAL HINGE INDUCTION CHAFING DISH
W/ GLASS WINDOWED LID
OPTIONAL GN2/3 FOOD PAN, 6Ltr
MATCHING STAND SS1032F
SPEC./产品尺寸:45.5X41X29CM
MEAS./包装尺寸: 46X42X30CM

方型机械缓冲式玻璃盖高级餐炉
配玻璃盖
可配GN2/3食物盆,6升
炉架: SS1032F

■ SS1032F

炉架



2



3

■ SS1021B

HALF SIZE MECHANICAL HINGE INDUCTION CHAFING DISH
OPTIONAL GN1/2 FOOD PAN, 4Ltr
MATCHING STAND SS1021F
SPEC./产品尺寸:45.5X32X29.5CM
MEAS./包装尺寸:46X33X31CM

方型机械缓冲式高级餐炉
可配GN1/2食物盆,4升
炉架: SS1021F

■ SS1021LB

HALF SIZE MECHANICAL HINGE INDUCTION CHAFING DISH
W/ GLASS WINDOWED LID
OPTIONAL GN1/2 FOOD PAN, 4Ltr
MATCHING STAND SS1021F
SPEC./产品尺寸:45.5X41X34CM
MEAS./包装尺寸:46X33X31CM

方型机械缓冲式玻璃盖高级餐炉
配玻璃盖
可配GN1/2食物盆,4升
炉架: SS1021F

■ SS1021F

炉架



2

Mechanical hinge induction chafing dish

Mechanical hinge induction
chafing dish

YUFEH
Kitchen Ware

SS1060B

ROUND MECHANICAL HINGE
INDUCTION CHAFING DISH
OPTIONAL Φ 35CM FOOD PAN, 6.0Ltr
MATCHING STAND SS1060F
SPEC./产品尺寸:52X45.5X29CM
MEAS./包装尺寸:52.5X46X30CM

圓型机械缓冲式高级餐炉
可配 Φ 35CM,6升食物盆
炉架: SS1060F



1

SS1060LB

ROUND MECHANICAL HINGE
INDUCTION CHAFING DISH
W/ GLASS WINDOWED LID
OPTIONAL Φ 35CM FOOD PAN, 6.0Ltr
MATCHING STAND SS1060F
SPEC./产品尺寸:52X45.5X29CM
MEAS./包装尺寸:52.5X46X30CM

圓型机械缓冲式玻璃盖高级餐炉
配玻璃盖
可配 Φ 35CM,6升食物盆
炉架: SS1060F



3

SS1060F

炉架



2



1

SS1040B

ROUND MECHANICAL HINGE
INDUCTION CHAFING DISH
OPTIONAL Φ 30CM FOOD PAN, 4.0Ltr
MATCHING STAND SS1040F
SPEC./产品尺寸:47X39X29CM
MEAS./包装尺寸:47.5X39.5X30CM

圓型机械缓冲式高级餐炉
可配 Φ 30CM,4升食物盆
炉架: SS1040F



3

SS1040LB

ROUND MECHANICAL HINGE
INDUCTION CHAFING DISH
W/ GLASS WINDOWED LID
OPTIONAL Φ 30CM FOOD PAN, 4.0Ltr
MATCHING STAND SS1040F
SPEC./产品尺寸:47X39X29CM
MEAS./包装尺寸:47.5X39.5X30CM

圓型机械缓冲式玻璃盖高级餐炉
配玻璃盖
可配 Φ 30CM,4升食物盆
炉架: SS1040F



2

SS1040F

炉架

Mechanical hinge induction chafing dish

Mechanical hinge induction chafing dish

YUFEH
Kitchen Ware

SS10-11B

ROUND MECHANICAL HINGE
INDUCTION SOUP STATION
OPTIONAL 11L SOUP BUCKET
MATCHING STAND SS10-11F
SPEC./产品尺寸:49.5x47x41.50CM
MEAS./包装尺寸:44x44x43CM

圆型机械缓冲式高级汤炉
可配11升汤桶
炉架: SS10-11F

SS10-11LB

ROUND MECHANICAL HINGE
INDUCTION SOUP STATION
W/ GLASS WINDOWED LID
OPTIONAL 11L SOUP BUCKET
MATCHING STAND SS10-11F
SPEC./产品尺寸:49.5x47x41.50CM
MEAS./包装尺寸:44x44x43CM

圆型机械缓冲式玻璃盖高级汤炉
配玻璃盖
可配11升汤桶
炉架: SS10-11F

SS10-11F

炉架

11L INSERT SOUP BUCKET

11升汤桶



1



3



4



2

S1011B

FULL SIZE MECHANICAL HINGE
INDUCTION CHAFING DISH
OPTIONAL GN1/1 FOOD PAN, 9.0Ltr
MATCHING STAND S1011F
SPEC./产品尺寸:60X47X29.5CM
MEAS./包装尺寸: 61X48X31.5

长方型机械缓冲式高级餐炉
可配GN1/1食物盆, 9.0升

S1011LB

FULL SIZE MECHANICAL HINGE
INDUCTION CHAFING DISH
W/ GLASS WINDOWED LID
OPTIONAL GN1/1 FOOD PAN, 9.0Ltr
MATCHING STAND S1011F
SPEC./产品尺寸:60X47X29.5CM
MEAS./包装尺寸: 61X48X31.5

长方型机械缓冲式玻璃盖高级餐炉
配玻璃盖
可配GN1/1食物盆, 9.0升

A1011P

INDUCTION PLATE/电磁炉固定板

S1011F

炉架



1



3



4



2

Mechanical hinge induction chafing dish

Mechanical hinge induction chafing dish

YUFEH
Kitchen Ware

S1032B

2/3 SIZE MECHANICAL HINGE
INDUCTION CHAFING DISH
OPTIONAL GN2/3 FOOD PAN, 6.0Ltr
MATCHING STAND S1032F
SPEC./产品尺寸:47X44X30CM
MEAS./包装尺寸: 48X45X32CM

方型机械缓冲式高级餐炉
可配GN2/3食物盆,6.0升



1

S1032LB

2/3 SIZE MECHANICAL HINGE
INDUCTION CHAFING DISH
W/ GLASS WINDOWED LID
OPTIONAL GN2/3 FOOD PAN, 6.0Ltr
MATCHING STAND S1032F
SPEC./产品尺寸:47X44X30CM
MEAS./包装尺寸: 48X45X32CM

方型机械缓冲式玻璃盖高级餐炉
配玻璃盖
可配GN2/3食物盆,6.0升



3



4

A1011P

INDUCTION PLATE/电磁炉固定板

S1032F

炉架



2



1

S1021B

HALF SIZE MECHANICAL HINGE
INDUCTION CHAFING DISH
OPTIONAL GN1/2 FOOD PAN, 4.0Ltr
MATCHING STAND S1021F
SPEC./产品尺寸:47X34X29.5CM
MEAS./包装尺寸:48X35X31.5CM

方型机械缓冲式高级餐炉
可配GN1/2食物盆,4.0升

S1021LB

HALF SIZE MECHANICAL HINGE
INDUCTION CHAFING DISH
W/ GLASS WINDOWED LID
OPTIONAL GN1/2 FOOD PAN, 4.0Ltr
MATCHING STAND S1021F
SPEC./产品尺寸:47X34X29.5CM
MEAS./包装尺寸:48X35X31.5CM

方型机械缓冲式玻璃盖高级餐炉
配玻璃盖
可配GN1/2食物盆,4.0升



2

Mechanical hinge induction chafing dish

SB10B series mechanical hinge induction chafing dish

YUFEH
Kitchen Ware

1 S1060B

ROUND MECHANICAL HINGE
INDUCTION CHAFING DISH
OPTIONAL Φ 35CM FOOD PAN, 6.0Ltr
MATCHING STAND S1060F
SPEC./产品尺寸:47X54X29CM
MEAS./包装尺寸:48X55X31CM

圆型机械缓冲式高级餐炉
可配 Φ 35CM,6升食物盆



1

2 S1060LB

ROUND MECHANICAL HINGE
INDUCTION CHAFING DISH
W/ GLASS WINDOWED LID
OPTIONAL Φ 35CM FOOD PAN, 6.0Ltr
MATCHING STAND S1060F
SPEC./产品尺寸:47X54X29CM
MEAS./包装尺寸:48X55X31CM

圆型机械缓冲式玻璃盖高级餐炉
配玻璃盖
可配 Φ 35CM,6升食物盆



2

1 SB1011B

FULL SIZE MECHANICAL HINGE
INDUCTION CHAFING DISH
OPTIONAL GN1/1 FOOD PAN,9Ltr
MATCHING STAND SB1011F
SPEC./产品尺寸:58.5X46X24.5CM
MEAS./包装尺寸: 59.5X47X27CM

长方形机械缓冲式钢盖高级餐炉
可配GN1/1食物盆,9升
炉架: SB1011F



1

2 SB1011LB

FULL SIZE MECHANICAL HINGE
INDUCTION CHAFING DISH
W/ GLASS WINDOWED LID
OPTIONAL GN1/1 FOOD PAN,9Ltr
MATCHING STAND SB1011F
SPEC./产品尺寸:58.5X46X24.5CM
MEAS./包装尺寸: 59.5X47X27CM

长方形机械缓冲式玻璃盖高级餐炉
配玻璃盖
可配GN1/1食物盆,9升
炉架: SB1011F

3 STACKABLE FRAME DESIGN

炉架叠式设计,方便储存

4 SB1011F

HEAT SOURCE: ELECTRICAL WARMER
炉架可使用电热板

5 8" STEAMER

8"蒸笼

OPTIONAL ACCESSORIES:
VITRIFIED NON-POROUS PORCELAIN
FOOD PAN
可使用: 强化瓷食物盆

6 P811-2

GN 1/1 FOOD PAN 9Ltr

7 P812-2

GN 1/2 FOOD PAN 4Ltr

8 P823-2

GN 2/3 FOOD PAN 6Ltr

9 P823/2-2

GN 2/3 DIVIDED FOOD PAN 6Ltr

10 P813-2

GN 1/3 FOOD PAN 2.5Ltr



3

4

5

6

7

8

9

10



2

SB10B series mechanical hinge induction chafing dish

SB10B series mechanical hinge induction chafing dish

YUFEH
Kitchen Ware

SB1032B

2/3 SIZE MECHANICAL HINGE INDUCTION CHAFING DISH
OPTIONAL GN2/3 FOOD PAN, 6Ltr
MATCHING STAND SB1032F
SPEC./产品尺寸: 46.5X41X24.5CM
MEAS./包装尺寸: 47.5X42X27CM

方型机械缓冲式钢盖高级餐炉
可配GN2/3食物盆, 6升
炉架: SB2032F

SB1032LB

2/3 SIZE MECHANICAL HINGE INDUCTION CHAFING DISH
W/ GLASS WINDOWED LID
OPTIONAL GN2/3 FOOD PAN, 6Ltr
MATCHING STAND SB1032F
SPEC./产品尺寸: 46.5X41X24.5CM
MEAS./包装尺寸: 47.5X42X27CM

方型机械缓冲式玻璃盖高级餐炉
配玻璃盖
可配GN2/3食物盆, 6升
炉架: SB1032F

SB1032F

HEAT SOURCE: ELECTRICAL WARMER
炉架可使用电热板

STACKABLE FRAME DESIGN

炉架叠式设计, 方便储存

OPTIONAL ACCESSORIES:
VITRIFIED NON-POROUS PORCELAIN
FOOD PAN
可使用: 强化瓷食物盆

P823-2

GN 2/3 FOOD PAN 6Ltr

P823/2-2

GN 2/3 DIVIDED FOOD PAN 6Ltr



1



3



4



5



6



2

SB1021B

HALF SIZE MECHANICAL HINGE INDUCTION CHAFING DISH
OPTIONAL GN1/2 FOOD PAN, 4Ltr
MATCHING STAND SB1021F
SPEC./产品尺寸: 45.5X32.5X24.5CM
MEAS./包装尺寸: 46.5X33.5X27CM

方型机械缓冲式钢盖高级餐炉
可配GN1/2食物盆, 4升
炉架: SB1021F

SB1021LB

HALF SIZE MECHANICAL HINGE INDUCTION CHAFING DISH
W/ GLASS WINDOWED LID
OPTIONAL GN1/2 FOOD PAN, 4Ltr
MATCHING STAND SB1021F
SPEC./产品尺寸: 45.5X32.5X24.5CM
MEAS./包装尺寸: 46.5X33.5X27CM

方型机械缓冲式玻璃盖高级餐炉
配玻璃盖
可配GN1/2食物盆, 4升
炉架: SB1021F

SB1021F

HEAT SOURCE: ELECTRICAL WARMER
炉架可使用电热板

STACKABLE FRAME DESIGN

炉架叠式设计, 方便储存

OPTIONAL ACCESSORIES:
VITRIFIED NON-POROUS PORCELAIN
FOOD PAN
可使用: 强化瓷食物盆

P812-2

GN 1/2 FOOD PAN 4Ltr



1



3



4



5



2

SB10 series mechanical hinge induction chafing dish

SB1060B

ROUND MECHANICAL HINGE
INDUCTION CHAFING DISH
OPTIONAL Φ 35CM FOOD PAN, 6Ltr
MATCHING STAND SB1060F
SPEC./产品尺寸: 52.5X45X24.5CM
MEAS./包装尺寸: 53.5X46X27CM

圆型机械缓冲式钢盖高级餐炉
可配 Φ 35CM, 6升食物盆
炉架: SB1060F

SB1060LB

ROUND MECHANICAL HINGE
INDUCTION CHAFING DISH
W/ GLASS WINDOWED LID
OPTIONAL Φ 35CM FOOD PAN, 6Ltr
MATCHING STAND SB1060F
SPEC./产品尺寸: 52.5X45X24.5CM
MEAS./包装尺寸: 53.5X46X27CM

圆型机械缓冲式玻璃盖高级餐炉
配玻璃盖
可配 Φ 35CM, 6升食物盆
炉架: SB1060F

10" STEAMER

10" 蒸笼

SB1060F

HEAT SOURCE: ELECTRICAL WARMER
炉架可使用电热板

STACKABLE FRAME DESIGN

炉架叠式设计, 方便储存

OPTIONAL ACCESSORIES:
VITRIFIED NON-POROUS PORCELAIN
FOOD PAN
可使用: 强化瓷食物盆

PRF36/2-2

Φ 33CM ROUND DIVIDED FOOD PAN,
5.8Ltr

PRF36-2

Φ 33CM ROUND FOOD PAN, 6Ltr



1



3



4



5



6



7



2

SB1040B

ROUND MECHANICAL HINGE
INDUCTION CHAFING DISH
OPTIONAL Φ 30CM FOOD PAN, 4Ltr
MATCHING STAND SB1040F
SPEC./产品尺寸: 47X39.5X24.5CM
MEAS./包装尺寸: 48X40.5X27CM

圆型机械缓冲式钢盖高级餐炉
可配 Φ 30CM, 4升食物盆
炉架: SB1040F

SB1040LB

ROUND MECHANICAL HINGE
INDUCTION CHAFING DISH
W/ GLASS WINDOWED LID
OPTIONAL Φ 30CM FOOD PAN, 4Ltr
MATCHING STAND SB1040F
SPEC./产品尺寸: 47X39.5X24.5CM
MEAS./包装尺寸: 48X40.5X24CM

圆型机械缓冲式玻璃盖高级餐炉
配玻璃盖
可配 Φ 30CM, 4升食物盆
炉架: SB1040F

SB1040F

HEAT SOURCE: ELECTRICAL WARMER
炉架可使用电热板

STACKABLE FRAME DESIGN

炉架叠式设计, 方便储存

OPTIONAL ACCESSORIES:
VITRIFIED NON-POROUS PORCELAIN
FOOD PAN
可使用: 强化瓷食物盆



10 SERIES WARM GRAVY SERVER

10-J4

WARM GRAVY SERVER
4Ltr
SPEC./产品尺寸: 26.5X24X33CM
MEAS./包装尺寸: 28X25.5X36.5CM

4升酱汁炉
可配4升酱汁盆

OPTIONAL ACCESSORIES:
VITRIFIED NON-POROUS
PORCELAIN GRAVY POT
可使用: 强化瓷酱汁盆

LPRF24-6

Φ24CM GRAVY POT, 4Ltr



2



3



4



1

10-J6

WARM GRAVY SERVER
6Ltr
SPEC./产品尺寸: 32.5X30X33CM
MEAS./包装尺寸: 34.5X32X36.5CM

6升酱汁炉
可配6升酱汁盆

OPTIONAL ACCESSORIES:
VITRIFIED NON-POROUS
PORCELAIN GRAVY POT
可使用: 强化瓷酱汁盆

LPRF24-6

Φ30CM GRAVY POT, 6Ltr



2



3



4

Coffee Urn

1 10-06

6L DELUX COFFEE URN
6L 热咖啡鼎
SPEC./产品尺寸:35x30x49.5CM
MEAS./包装尺寸: 38X33X53CM

2 10-M6

6L MILK CAN
6L 牛奶桶
SPEC./产品尺寸:26X20.4X44.5CM
MEAS./包装尺寸: 27.5X27.5X48CM

3 10-12

12L DELUX COFFEE URN
12L 热咖啡鼎
SPEC./产品尺寸:35x30x49.5CM
MEAS./包装尺寸: 38X33X53CM



1 10-12P

12L DELUX JUICE DISPENSER
PC BODY
12L 热/冷果汁鼎
桶身: PC料
SPEC./产品尺寸:35X30X49.5CM
MEAS./包装尺寸:38X33X53CM

2 10-13

13L DELUX COFFEE URN
13L 热咖啡鼎
SPEC./产品尺寸:28.5x26.5x63.5CM
MEAS./包装尺寸: 32X29X66CM

3 10-19

19L DELUX COFFEE URN
19L 热咖啡鼎
SPEC./产品尺寸:35x31x62CM
MEAS./包装尺寸: 38X33X55CM





■ P12-5

SINGLE JUICE DISPENSER
单头果汁鼎

CAP./规格: 5 Ltr
SPEC./产品尺寸:
BODY 上装: 15X15X58.5CM
FRAME 下装: 35X23X29.7CM
MEAS./包装尺寸:
BODY 上装: 15.5X15.5X61CM
FRAME 下装: 35.5X23.5X32CM

■ P15-8

SINGLE JUICE DISPENSER
单头果汁鼎

CAP./规格: 8Ltr
SPEC./产品尺寸:
BODY 上装: 17.5X17.5X58.5CM
FRAME 下装: 35X23X29.7CM
MEAS./包装尺寸:
BODY 上装: 18X18X61CM
FRAME 下装: 35.5X23.5X32CM

■ P18-12

SINGLE JUICE DISPENSER
单头果汁鼎

CAP./规格: 12Ltr
SPEC./产品尺寸:
BODY 上装: 20.3X20.3X59CM
FRAME 下装: 35X23X29.7CM
MEAS./包装尺寸:
BODY 上装: 21X21X61CM
FRAME 下装: 35.5X23.5X32CM



■ C12-5

CEREAL DISPENSER
单头麦片机

CAP./规格: 5 Ltr
SPEC./产品尺寸:
BODY 上装: 17.2X12.5X60CM
FRAME 下装: 35X23X34.3CM
MEAS./包装尺寸:
BODY 上装: 18X13X62CM
FRAME 下装: 35.5X23.5X36.5CM

■ C15-8

CEREAL DISPENSER
单头麦片机

CAP./规格: 8Ltr
SPEC./产品尺寸:
BODY 上装: 20X15.5X61CM
FRAME 下装: 35X23X35.2CM
MEAS./包装尺寸:
BODY 上装: 20.5X16X63CM
FRAME 下装: 35.5X23.5X37.5CM

■ C18-12

CEREAL DISPENSER
单头麦片机

CAP./规格: 12Ltr
SPEC./产品尺寸:
BODY 上装: 23X18.6X61.7CM
FRAME 下装: 35X23X36.3CM
MEAS./包装尺寸:
BODY 上装: 23.5X19X64CM
FRAME 下装: 35.5X23.5X38.5CM



MOVABLE TANK
WITH HANDLE,
CONVENIENT FOR
CUSTOMER USAGE

可旋转式麦片机桶身，
可方便不同顾客的使用习惯

NEW
新品



10C Series Spring Hinged Induction chafing dish



- YUFEH's new series delux induction chafing dish in 2017.**
- Upgrade function with New spring hinged design.
 - The dish itself can compatible with induction plates or along with matching frame for a more classic buffet environment.
 - The patented spring hinged mechanism gives an extremely smooth lid motion. OPEN COVER EASILY AND EFFORTLESSLY.
- 宇辉2017年最新系列自助餐炉
 - 在原机械缓冲式餐炉的基础上进行新一代结构开发, 功能再次升级
 - 可独立使用于电磁炉或电热板上, 亦可选配炉架, 使用电磁炉或燃料
 - 最新注册设计的弹簧式链接结构, 开盖不费力, 60° 至 90° 任意角度停留, 经久耐用

REMOVABLE COVER
easy for cleaning and storage
可拆卸式炉盖方便清洗及储存

REMOVABLE COVER
SPRING COVER DESIN.OPEN COVER EASILY AND EFFORTLESSLY
可拆卸式炉盖方便清洗及储存



10C Series Spring Hinged Induction chafing dish | YUFEH® Kitchen Ware



1011C
FULL SIZE SPRING HINGED INDUCTION CHAFING DISH
OPTIONAL GN1/1 FOOD PAN,9Ltr
MATHCING STAND 1011CF
SPEC./产品尺寸
BODY上装: 59X41X20.3CM
FRAME下装: 57.3X37.2X22CM
MEAS./包装尺寸:
BODY上装: 59.5X43.5X25CM
FRAME下装: 58X38.5X24CM

长方型弹簧缓冲式锅盖高级餐炉
可配GN1/1食物盆,9升
炉架: 1011CF



1011LC
FULL SIZE SPRING HINGED INDUCTION CHAFING DISH
W/ GLASS WINDOWED LID
OPTIONAL GN1/1 FOOD PAN,9Ltr
MATHCING STAND 1011CF
SPEC./产品尺寸
BODY上装: 59X41X20.3CM
FRAME下装: 57.3X37.2X22CM
MEAS./包装尺寸:
BODY上装: 63.5X50.5X27CM
FRAME下装: 59X37.5X16CM

长方型弹簧缓冲式玻璃盖高级餐炉
配玻璃盖
可配GN1/1食物盆,9升
炉架: 1011CF

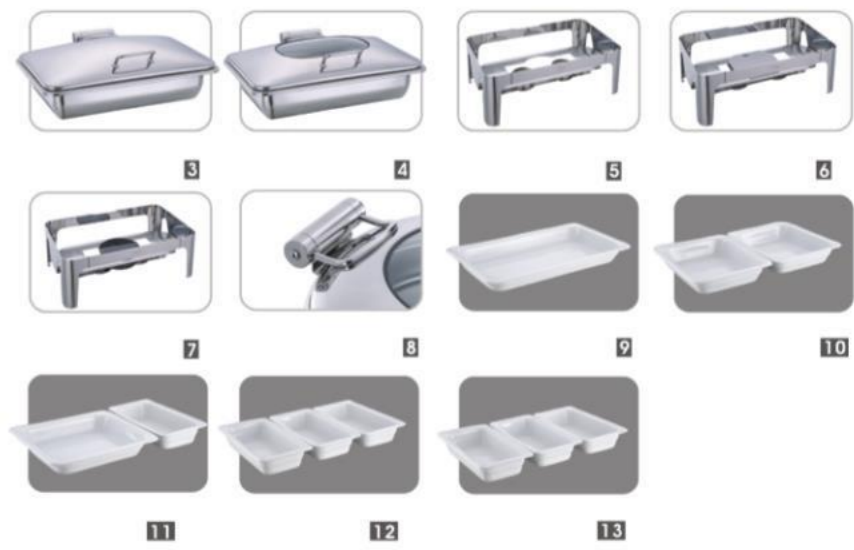

1011CF
HEAT SOURCE:INDUCTION COOKER, ELECTRICAL WARMER
炉架可搭配电磁炉, 电热板

OPTIONAL ACCESSORIES:
VITRIFIED NON-POROUS PORCELAIN FOOD PAN
可使用: 强化瓷食物盆

- P811-2**
GN 1/1 FOOD PAN 9Ltr
- P812-2**
GN 1/2 FOOD PAN 4Ltr
- P823-2**
GN 2/3 FOOD PAN 6Ltr
- P823/2-2**
GN 2/3 DIVIDED FOOD PAN 6Ltr
- P813-2**
GN 1/3 FOOD PAN 2.5Ltr



10C Series Spring Hinged Induction chafing dish



1

1032C

2/3 SIZE SPRING HINGED INDUCTION CHAFING DISH
 OPTIONAL GN2/3 FOOD PAN, 6Ltr
 MATCHING STAND 1032CF
 SPEC./产品尺寸
 BODY上装: 41.5X41X19.5CM
 FRAME下装: 39.6X37.2X22CM
 MEAS./包装尺寸:
 BODY上装: 43X42X24CM
 FRAME下装: 40X38.5X24CM

方型弹簧缓冲式钢盖高级餐炉
 可配GN2/3食物盆,6升
 炉架: 1032CF



1032LC

2/3 SIZE SPRING HINGED INDUCTION CHAFING DISH
 W/ GLASS WINDOWED LID
 OPTIONAL GN2/3 FOOD PAN, 6Ltr
 MATCHING STAND 1032CF
 SPEC./产品尺寸
 BODY上装: 41.5X41X19.5CM
 FRAME下装: 39.6X37.2X22CM
 MEAS./包装尺寸:
 BODY上装: 43X42X24CM
 FRAME下装: 40X38.5X24CM

方型弹簧缓冲式玻璃盖高级餐炉
 配玻璃盖
 可配GN2/3食物盆,6升
 炉架: 1032CF

1032CF

HEAT SOURCE:INDUCTION COOKER,
 ELECTRICAL WARMER
 炉架可搭配电磁炉,电热板

OPTIONAL ACCESSORIES:
 VITRIFIED NON-POROUS PORCELAIN
 FOOD PAN
 可使用: 强化瓷食物盆

P823-2

GN 2/3 FOOD PAN 6Ltr

P823/2-2

GN 2/3 DIVIDED FOOD PAN 6Ltr



2

10C Series Spring Hinged Induction chafing dish



1

1021C

HALF SIZE SPRING HINGED INDUCTION CHAFING DISH
 OPTIONAL GN1/2 FOOD PAN, 4Ltr
 MATCHING STAND 1021CF
 SPEC./产品尺寸
 BODY上装: 41.5X32.5X19.5CM
 FRAME下装: 36.7X30.7X22CM
 MEAS./包装尺寸:
 BODY上装: 44X33X24CM
 FRAME下装: 38.5X31X24CM

方型弹簧缓冲式钢盖高级餐炉
 可配GN1/2食物盆,4升
 炉架: 1021CF

1021LC

HALF SIZE SPRING HINGED INDUCTION CHAFING DISH
 W/ GLASS WINDOWED LID
 OPTIONAL GN1/2 FOOD PAN, 4Ltr
 MATCHING STAND 1021CF
 SPEC./产品尺寸
 BODY上装: 41.5X32.5X19.5CM
 FRAME下装: 36.7X30.7X22CM
 MEAS./包装尺寸:
 BODY上装: 44X33X24CM
 FRAME下装: 38.5X31X24CM

方型弹簧缓冲式玻璃盖高级餐炉
 配玻璃盖
 可配GN1/2食物盆,4升
 炉架: 1021CF

1021CF

HEAT SOURCE:INDUCTION COOKER,
 ELECTRICAL WARMER
 炉架可搭配电磁炉,电热板

OPTIONAL ACCESSORIES:
 VITRIFIED NON-POROUS PORCELAIN
 FOOD PAN
 可使用: 强化瓷食物盆

P812-2

GN 1/2 FOOD PAN 4Ltr



2

10C Series Spring Hinged Induction chafing dish

**NEW
新品**



1060C

ROUND SPRING HINGED INDUCTION CHAFING DISH
OPTIONAL Φ 35CM FOOD PAN, 6Ltr
MATCHING STAND 1060CF
SPEC./产品尺寸
BODY 上装: 47.5X45.5X19.5CM
FRAME 下装: 44.5X44.5X22CM
MEAS./包装尺寸:
BODY 上装: 46X46X24CM
FRAME 下装: 44X44X24CM
圆型弹簧缓冲式钢盖高级餐炉
可配 Φ 35CM, 6升食物盆
炉架: 1060CF

1060LC

ROUND SPRING HINGED INDUCTION CHAFING DISH
W/ GLASS WINDOWED LID
OPTIONAL Φ 35CM FOOD PAN, 6Ltr
MATCHING STAND 1060CF
SPEC./产品尺寸
BODY 上装: 47.5X45.5X19.5CM
FRAME 下装: 44.5X44.5X22CM
MEAS./包装尺寸:
BODY 上装: 46X46X24CM
FRAME 下装: 44X44X24CM
圆型弹簧缓冲式玻璃盖高级餐炉
配玻璃盖
可配 Φ 35CM, 6升食物盆
炉架: 1060CF

1060CF

HEAT SOURCE:INDUCTION COOKER,
ELECTRICAL WARMER
炉架可搭配电磁炉,电热板

OPTIONAL ACCESSORIES:
VITRIFIED NON-POROUS PORCELAIN
FOOD PAN
可使用: 强化瓷食物盆

PRF36/2-2

Φ 33CM ROUND DIVIDED FOOD PAN,
5.8Ltr

PRF36-2

Φ 33CM ROUND FOOD PAN, 6Ltr



10C Series Spring Hinged Induction chafing dish | YUFEH[®] Kitchen Ware

**NEW
新品**

1040C

ROUND SPRING HINGED INDUCTION CHAFING DISH
OPTIONAL Φ 30CM FOOD PAN, 4Ltr
MATCHING STAND 1040CF
SPEC./产品尺寸
BODY 上装: 42X38.5X19CM
FRAME 下装: 37.8X37.8X22CM
MEAS./包装尺寸:
BODY 上装: 41X41X24CM
FRAME 下装: 37.5X37.5X24CM

圆型弹簧缓冲式钢盖高级餐炉
可配 Φ 30CM 4升食物盆
炉架: 1040CF

1040LC

ROUND SPRING HINGED CHAFING DISH
W/ GLASS WINDOWED LID
OPTIONAL Φ 30CM FOOD PAN, 4Ltr
MATCHING STAND 1040LC
SPEC./产品尺寸
BODY 上装: 42X38.5X19CM
FRAME 下装: 37.8X37.8X22CM
MEAS./包装尺寸:
BODY 上装: 41X41X24CM
FRAME 下装: 37.5X37.5X24CM

圆型弹簧缓冲式玻璃盖高级餐炉
配玻璃盖
可配 Φ 30CM 4升食物盆
炉架: 1040CF

1040CF

HEAT SOURCE:INDUCTION COOKER,
ELECTRICAL WARMER
炉架可搭配电磁炉,电热板

OPTIONAL ACCESSORIES:
VITRIFIED NON-POROUS PORCELAIN
FOOD PAN
可使用: 强化瓷食物盆

PRF28/2-2

Φ 28CM ROUND DIVIDED FOOD PAN,
3.8Ltr

PRF28-2

Φ 28CM ROUND FOOD PAN, 4Ltr



10C Series Spring Hinged Induction chafing dish

**NEW
新品**



10-11C

ROUND SPRING HINGED INDUCTION SOUP STATION
OPTIONAL 11L SOUP BUCKET
MATCHING STAND 10-11CF
SPEC./产品尺寸:
BODY上装: 41X41X29CM
FRAME下装: 37.8X37.8X22CM
MEAS./包装尺寸:
BODY上装: 42X42X33.5CM
FRAME下装: 37.5X37.5X24CM
圆型弹簧缓冲式钢盖高级汤炉
可配11L汤桶
炉架: 10-11CF



10-11LC

ROUND SPRING HINGED INDUCTION SOUP STATION
W/ GLASS WINDOWED LID
OPTIONAL 11L SOUP BUCKET
MATCHING STAND 10-11CF
SPEC./产品尺寸:
BODY上装: 41X41X29CM
FRAME下装: 37.8X37.8X22CM
MEAS./包装尺寸:
BODY上装: 42X42X33.5CM
FRAME下装: 37.5X37.5X24CM
圆型弹簧缓冲式玻璃盖高级汤炉
配玻璃盖
可配11L汤桶
炉架: 10-11CF



10-11CF

10-11CF

HEAT SOURCE:INDUCTION COOKER/
ELECTRICAL WARMER
炉架可搭配电磁炉,电热板

11L SOUP BUCKET
11升汤桶



1033B

CLASSICAL OBLONG CHAFING DISH
STAND WITH TUBULAR STEEL LEGS
W/ GN 1/1 FOOD PAN 9.0 LTR
SPEC./产品尺寸:69x54x50.5CM
MEAS./包装尺寸: 70X55X39CM

长方形机械缓冲式经典全翻盖餐炉
不锈钢管状脚
可配GN1/1食物盆,9升

1038B

OPTIONAL 2X4.5Ltr SOUP BUCKETS
SPEC./产品尺寸:69x54x50.5CM
MEAS./包装尺寸: 70X55X41CM
可配2只4.5升汤桶

STAYS OPEN AT 90°

盖子可打开90°

FULLY OPEN AT 180°

盖子可打开180°

STACKABLE DESIGN

叠式设计, 方便储存

HEAT SOURCE OPTION:

INDUCTIONCOOKER/
ELECTRICAL WARMER
可自由搭配电磁炉或电热板

CLASSICAL MECHANICAL HINGE
ROLL TOP CHAFING DISH

YUFEH
Kitchen Ware



CLASSICAL MECHANICAL HINGE ROLL TOP CHAFING DISH

CLASSICAL MECHANICAL HINGE
ROLL TOP CHAFING DISH

YUFEH
Kitchen Ware



1031B

CLASSICAL ROUND CHAFING DISH
STAND WITH TUBULAR STEEL LEGS
W/ Ø35CM FOOD PAN 6LTR
SPEC./产品尺寸:57.5x55.5x54CM
MEAS./包装尺寸: 60.5X59.5X39CM
圆型机械缓冲式经典全翻盖餐炉
不锈钢管状脚
可配Ø35CM, 6升食物盆

1030B

OPTIONAL 10Ltr SOUP BUCKETS
SPEC./产品尺寸:57.5x55.5x54CM
MEAS./包装尺寸: 60.5X59.5X45.5CM
可配10升汤桶

STAYS OPEN AT 90°

盖子可打开90°

FULLY OPEN AT 180°

盖子可打开180°

STACKABLE DESIGN

叠式设计, 方便储存

HEAT SOURCE OPTION:

INDUCTIONCOOKER/
ELECTRICAL WARMER
可自由搭配电磁炉或电热板



10032B

CLASSICAL 2/3 SIZE ROLL TOP CHAFING
DISH MECHANICAL HINGE
STAND WITH TUBULAR STEEL LEGS
W/ GN 2/3 FOOD PAN 6.0Ltr
SPEC./产品尺寸:50.5X54X49.5CM
MEAS./包装尺寸:55X53X36CM
方型机械缓冲式经典全翻盖餐炉
不锈钢管状脚
可配GN2/3食物盆,6.0升

DETACHABLE LID

FOR QUICK & EASY CLEANING
炉盖可轻易拆出: 清洗方便

STAYS OPEN AT 90°

FULLY OPEN AT 180°

盖子可打开90° 或180°

STACKABLE DESIGN

叠式设计, 方便储存



CLASSICAL MECHANICAL HINGE ROLL TOP CHAFING DISH

1033

CLASSICAL OBLONG CHAFING DISH
STAND WITH CASTED ALLOY LEGS
W/ GN 1/1 FOOD PAN 9.0 LTR
SPEC./产品尺寸:69x54.5x50CM
MEAS./包装尺寸: 70X52X39CM

长方形机械缓冲式经典全翻盖餐炉
合金铸脚
可配GN1/1食物盆,9升

1038

OPTIONAL 2X4.5Ltr SOUP BUCKETS
可配2只4.5升汤桶

STAYS OPEN AT 90°

盖子可打开90°

FULLY OPEN AT 180°

盖子可打开180°

STACKABLE DESIGN

叠式设计, 方便储存

HEAT SOURCE OPTION:

INDUCTIONCOOKER/
ELECTRICAL WARMER
可自由搭配电磁炉或电热板



1031

CLASSICAL ROUND CHAFING DISH
STAND WITH CASTED ALLOY LEGS
W/ Φ35CM FOOD PAN 6LTR
SPEC./产品尺寸:58X56.5X52.5
MEAS./包装尺寸: 58X56.5X39CM

圆形机械缓冲式经典全翻盖餐炉
合金铸脚
可配Φ35CM, 6升食物盆

1030

OPTIONAL 10Ltr SOUP BUCKETS
可配10升汤桶

STAYS OPEN AT 90°

盖子可打开90°

FULLY OPEN AT 180°

盖子可打开180°

STACKABLE DESIGN

叠式设计, 方便储存

HEAT SOURCE OPTION:

INDUCTIONCOOKER/
ELECTRICAL WARMER
可自由搭配电磁炉或电热板



CLASSICAL MECHANICAL HINGE ROLL TOP CHAFING DISH

10032

CLASSICAL 2/3 SIZE ROLL TOP
CHAFING DISH MECHANICAL HINGE
STAND WITH CASTED ALLOY LEGS
W/ GN 2/3 FOOD PAN 6.0Ltr
SPEC./产品尺寸:50.5X54X49CM
MEAS./包装尺寸:55X53X36CM
方型机械缓冲式经典全翻盖餐炉
合金铸脚
可配GN2/3食物盆,6.0升

DETACHABLE LID

FOR QUICK & EASY CLEANING
炉盖可轻易拆出:清洗方便

STAYS OPEN AT 90°

FULLY OPEN AT 180°

盖子可打开90°或180°

STACKABLE DESIGN

叠式设计,方便储存



1031E

TABLE-TOP DELUXE
ROLL TOP CHAFING DISH
W/ Φ35CM FOOD PAN 6LTR
SPEC./产品尺寸:55.5X58X28.5CM
MEAS./包装尺寸:56.5x59x29.5CM

圆型嵌入式机械缓冲经典全翻盖餐炉
可配Φ35CM, 6升食物盆

YH731E

TABLE-TOP ROUND ROLL TOP
CHAFING DISH
W/ Φ35CM FOOD PAN 6LTR
SPEC./产品尺寸:48X53X27CM
MEAS./包装尺寸:49X54X28CM

圆型嵌入式全翻盖豪华餐炉
可配Φ35CM, 6升食物盆



DELUXE MECHANICAL HINGE ROLL TOP CHAFING DISH

DELUXE MECHANICAL
HINGE ROLL TOP CHAFING DISH

YUFEH
Kitchen Ware

1033S

OBLONG CHAFING DISH
MECHANICAL HINGE
STAND WITH HOLLOW STEEL LEGS
W/ GN 1/1 FOOD PAN 9.0 LTR

长方形豪华机械缓冲豪华全翻盖餐炉
仿铸脚
可配GN1/1食物盆,9升
SPEC./产品尺寸:68X48.5X45.3CM
MEAS./包装尺寸:75X50X35CM

STAYS OPEN AT 90°

盖子可打开90°

FULLY OPEN AT 180°

盖子可打开90° 或180°

STACKABLE DESIGN

叠式设计, 方便储存

HEAT SOURCE OPTION:
INDUCTION COOKER/
ELECTRICAL WARMER
可自由搭配电磁炉或电热板

STACKABLE DESIGN

FOR QUICK & EASY CLEANING
炉盖可轻易拆出: 清洗方便



1

1031S

ROUND CHAFING DISH
MECHANICAL HINGE
STAND WITH HOLLOW STEEL LEGS
W/ Ø35CM FOOD PAN 6LTR

圆型机械缓冲式豪华全翻盖餐炉
仿铸脚
可配Ø35CM, 6升食物盆
SPEC./产品尺寸:54X50X47.8CM
MEAS./包装尺寸:55X55X35CM

STAYS OPEN AT 90°

盖子可打开90°

FULLY OPEN AT 180°

盖子可打开90° 或180°

STACKABLE DESIGN

叠式设计, 方便储存

HEAT SOURCE OPTION:
INDUCTION COOKER/
ELECTRICAL WARMER
可自由搭配电磁炉或电热板

STACKABLE DESIGN

FOR QUICK & EASY CLEANING
炉盖可轻易拆出: 清洗方便



1



2



3



5



4

DELUXE ROLL TOP CHAFING DISH



1033E

TABLE TOP DELUXE
ROLL TOP CHAFING DISH
W/ GN 1/1 FOOD PAN 9.0 Ltr
SPEC./产品尺寸:69.5x55x25CM
MEAS./包装尺寸: 70.5x56x26cm

长方形嵌入式机械缓冲经典全翻盖餐炉
可配GN1/1食物盆,9升

YH733E

TABLE TOP OBLONG ROLL TOP
CHAFING DISH
W/ GN 1/1 FOOD PAN 9.0Ltr
SPEC./产品尺寸:63X47.5X23.5CM
MEAS./包装尺寸: 64x48.5x24.5CM

长方形嵌入式全翻盖豪华餐炉
可配GN1/1食物盆,9升



DELUXE MECHANICAL HINGE
ROLL TOP CHAFING DISH

YUFEH
Kitchen Ware

1033B-01

DELUXE OBLONG CHAFING DISH
MECHANICAL HINGE
STAND WITH TUBULAR STEEL LEGS
W/ GN 1/1 FOOD PAN 9.0 Ltr
SPEC./产品尺寸:69x54x50.5CM
MEAS./包装尺寸: 70X55X39CM

长方形机械缓冲式豪华全翻盖餐炉
不锈钢管状脚
可配GN1/1食物盆,9升

1038B-01

OPTIONAL 2X4.5Ltr SOUP BUCKETS
可配2只4.5升汤桶
SPEC./产品尺寸:69x54x50.5CM
MEAS./包装尺寸: 70X55X41CM

STAYS OPEN AT 90°

盖子可打开90° 或180°

FULLY OPEN AT 180°

DETACHABLE LID

FOR QUICK & EASY CLEANING
炉盖可轻易拆出: 清洗方便

STACKABLE DESIGN

叠式设计, 方便储存

HEAT SOURCE OPTION:

INDUCTIONCOOKER/
ELECTRICAL WARMER
可自由搭配电磁炉或电热板



Deluxe mechanical hinge roll top chafing dish

Deluxe mechanical hinge roll top chafing dish

YUFEH
Kitchen Ware

1031B-01

ROUND CHAFING DISH
MECHANICAL HINGE
STAND WITH TUBULAR STEEL LEGS
W/ Φ 35CM FOOD PAN 6.0 Ltr
SPEC./产品尺寸:57.5x55.5x54CM
MEAS./包装尺寸: 60.5X59.5X39CM

圆型机械缓冲式豪华全翻盖餐炉
不锈钢管状脚
可配 Φ 35CM, 6升食物盆

1030B-01

OPTIONAL 10Ltr SOUP BUCKETS
可配10升汤桶
SPEC./产品尺寸:57.5x55.5x54CM
MEAS./包装尺寸: 60.5X59.5X45.5CM

STAYS OPEN AT 90°

盖子可打开90° 或180°

FULLY OPEN AT 180°

STACKABLE DESIGN

叠式设计, 方便储存

DETACHABLE LID

FOR QUICK & EASY CLEANING
炉盖可轻易拆出: 清洗方便

HEAT SOURCE OPTION:

INDUCTION COOKER/
ELECTRICAL WARMER
可自由搭配电磁炉或电热板



10032B-01

DELUXE 2/3 SIZE ROLL TOP CHAFING DISH
MECHANICAL HINGE
STAND WITH TUBULAR STEEL LEGS
W/ GN 2/3 FOOD PAN 6.0Ltr
SPEC./产品尺寸:50.5X54X49.5CM
MEAS./包装尺寸:55X53X36CM

方型机械缓冲式豪华全翻盖餐炉
不锈钢管状脚
可配GN2/3食物盆, 6.0升

DETACHABLE LID

FOR QUICK & EASY CLEANING
炉盖可轻易拆出: 清洗方便

STAYS OPEN AT 90°

FULLY OPEN AT 180°

盖子可打开90° 或180°

STACKABLE DESIGN

叠式设计, 方便储存



Deluxe mechanical hinge roll top chafing dish

Deluxe mechanical hinge roll top chafing dish

YUFEH
Kitchen Ware

1033-01

DELUXE OBLONG CHAFING DISH
MECHANICAL HINGE
STAND WITH HOLLOW STEEL LEGS
W/ GN 1/1 FOOD PAN 9.0 Ltr
SPEC./产品尺寸: 69x54.5x50CM
MEAS./包装尺寸: 70X52X39CM

长方形机械缓冲式豪华全翻盖餐炉
仿铸脚
可配GN1/1食物盆, 9升

1038-01

OPTIONAL 2X4.5Ltr SOUP BUCKETS
可配2只4.5升汤桶

STAYS OPEN AT 90°

盖子可打开90° 或180°

FULLY OPEN AT 180°

DETACHABLE LID

FOR QUICK & EASY CLEANING
炉盖可轻易拆出: 清洗方便

STACKABLE DESIGN

叠式设计, 方便储存

HEAT SOURCE OPTION:

INDUCTIONCOOKER/
ELECTRICAL WARMER
可自由搭配电磁炉或电热板



1031-01

DELUXE ROUND CHAFING DISH
MECHANICAL HINGE
STAND WITH HOLLOW STEEL LEGS
W/ Φ35CM FOOD PAN 6.0 Ltr
SPEC./产品尺寸: 58X56.5X52.5
MEAS./包装尺寸: 58X56.5X39CM

圆型机械缓冲式豪华全翻盖餐炉
仿铸脚
可配Φ35CM, 6升食物盆

1030-01

OPTIONAL 10Ltr SOUP BUCKETS
可配10升汤桶

STAYS OPEN AT 90°

盖子可打开90° 或180°

FULLY OPEN AT 180°

STACKABLE DESIGN

叠式设计, 方便储存

DETACHABLE LID

FOR QUICK & EASY CLEANING
炉盖可轻易拆出: 清洗方便

HEAT SOURCE OPTION:

INDUCTIONCOOKER/
ELECTRICAL WARMER
可自由搭配电磁炉或电热板



Deluxe mechanical hinge roll top chafing dish

Deluxe mechanical hinge roll top chafing dish

YUFEH
Kitchen Ware

1 10032-01

DELUXE 2/3 SIZE ROLL TOP CHAFING DISH
MECHANICAL HINGE
STAND WITH HOLLOW STEEL LEGS
W/ GN 2/3 FOOD PAN 6.0Ltr
SPEC./产品尺寸:50.5X54X49CM
MEAS./包装尺寸:55X53X36CM
方型机械缓冲式豪华全翻盖餐炉
仿铸脚
可配GN2/3食物盆,6.0升

2 DETACHABLE LID

FOR QUICK & EASY CLEANING
炉盖可轻易拆出:清洗方便

3 STAYS OPEN AT 90°

4 FULLY OPEN AT 180°

盖子可打开90° 或180°

5 STACKABLE DESIGN

叠式设计,方便储存



2



3



4



5



1



1



2



3



4



5

1 100P

SINGLE CEREAL DISPENSER
单头麦片机

CAP./规格: 9.0L
SPEC./产品尺寸:34.5x25x66cm
MEAS./包装尺寸: 35.5x26x67cm

2 D0031

SINGLE JUICE DISPENSER
单头果汁鼎

CAP./规格: 8.0L
SPEC./产品尺寸:27x36x59cm
MEAS./包装尺寸: 37x28x61cm

3 D0041

SINGLE MILK DISPENSER
单头奶鼎

CAP./规格: 8.0L
SPEC./产品尺寸:27x36x53cm
MEAS./包装尺寸: 37x28x55cm

4 D0032

DOUBLE JUICE DISPENSER
双头果汁鼎

CAP./规格: 2x8.0L
SPEC./产品尺寸:58x36x59cm
MEAS./包装尺寸: 60x37x61cm

5 D0042

DOUBLE MILK DISPENSER
双头奶鼎

CAP./规格: 2x8.0L
SPEC./产品尺寸:58x36x53cm
MEAS./包装尺寸: 60x37x55cm

Coffee Urn



YH733L

OBLONG ROLL TOP CHAFING DISH
W/ SHOW WINDOW
W/ GN1/1 FOOD PAN 9.0Ltr
SPEC./产品尺寸: 63X48X45CM
MEAS./包装尺寸: 73X49X34CM

长方形天窗全翻盖豪华餐炉
可视天窗
可配GN1/1食物盆, 9升

DETACHABLE LID
FOR QUICK & EASY CLEANING
炉盖可轻易拆出: 清洗方便

STAYS OPEN AT 90°

FULLY OPEN AT 180°
盖子可打开90° 或180°

HEAT SOURCE OPTION:
INDUCTION COOKER
ELECTRICAL WARMER
可自由搭配电磁炉或电热板

STACKABLE DESIGN
叠式设计, 方便储存



ROLL TOP CHAFING DISH

YH732L

2/3 SIZE ROLL TOP CHAFING DISH
W/ SHOW WINDOW
W/ GN2/3 FOOD PAN 6.0Ltr
SPEC./产品尺寸: 48.5X47X44.5CM
MEAS./包装尺寸: 51X49X34CM

2/3方型天窗全翻盖豪华餐炉
可视天窗
可配GN2/3食物盆, 6升

DETACHABLE LID
FOR QUICK & EASY CLEANING
炉盖可轻易拆出: 清洗方便

STAYS OPEN AT 90°
FULLY OPEN AT 180°
盖子可打开90° 或180°

HEAT SOURCE OPTION:
INDUCTION COOKER
ELECTRICAL WARMER
可自由搭配电磁炉或电热板

STACKABLE DESIGN
叠式设计, 方便储存



1



2



3



4

YH733

OBLONG ROLL TOP CHAFING DISH
STAND WITH HOLLOW STEEL LEGS
W/ GN 1/1 FOOD PAN 9.0Ltr
SPEC./产品尺寸: 63X48X45CM
MEAS./包装尺寸: 73X49X34CM

长方形全翻盖豪华餐炉
仿铸脚
可配GN1/1食物盆, 9升

DETACHABLE LID

FOR QUICK & EASY CLEANING
炉盖可轻易拆出: 清洗方便

YH738

OPTIONAL 2X4.5Ltr SOUP BUCKETS
SPEC./产品尺寸: 63X48X45CM
MEAS./包装尺寸: 73X49X39CM
可配2只4.5升汤桶

YH733-2

OPTIONAL 2X1/2 FOOD PAN
可配2只1/2食物盆

STAYS OPEN AT 90°

盖子可打开90°

STACKABLE DESIGN

叠式设计, 方便储存

FULLY OPEN AT 180°

盖子可打开180°

HEAT SOURCE OPTION:

INDUCTION COOKER
ELECTRICAL WARMER
可自由搭配电磁炉或电热板



1



ROLL TOP CHAFING DISH



YH731

ROUND ROLL TOP CHAFING DISH
STAND WITH HOLLOW STEEL LEGS
W/ Ø35CM FOOD PAN 6LTR
SPEC./产品尺寸:52X48.5X47CM
MEAS./包装尺寸: 53X53X35CM

圆型全翻盖豪华餐炉
仿铸脚
可配Ø35CM, 6升食物盆

YH730

OPTIONAL 10Ltr SOUP BUCKETS
SPEC./产品尺寸:52X48.5X47CM
MEAS./包装尺寸: 53X53X39CM
可配10升汤桶

STAYS OPEN AT 90°

盖子可打开90°

FULLY OPEN AT 180°

盖子可打开180°

STACKABLE DESIGN

叠式设计, 方便储存

HEAT SOURCE OPTION:

INDUCTION COOKER
ELECTRICAL WARMER
可自由搭配电磁炉或电热板



YH732

2/3 SIZE ROLL TOP CHAFING DISH
W/ GN 2/3 FOOD PAN 6.0Ltr
SPEC./产品尺寸:48.5X47X44.5CM
MEAS./包装尺寸:51X49X34CM

2/3 方型全翻盖豪华餐炉
可配GN2/3食物盆,6.0升

DETACHABLE LID

FOR QUICK & EASY CLEANING
炉盖可轻易拆出: 清洗方便

STAYS OPEN AT 90°

FULLY OPEN AT 180°

盖子可打开90° 或 180°

STACKABLE DESIGN

叠式设计, 方便储存



ROLL TOP CHAFING DISH

YH733GH

OBLONG ROLL TOP CHAFING DISH
STAND WITH HOLLOW STEEL LEGS
W/ GN 1/1 FOOD PAN 9.0Ltr
W/GOLDEN PLATED
SPEC./产品尺寸:63X48X45CM
MEAS./包装尺寸: 73X49X34CM

长方型镀金全翻盖豪华餐炉
仿铸脚
可配GN1/1食物盆,9升

HEAT SOURCE OPTION:

INDUCTION COOKER
ELECTRICAL WARMER
可自由搭配电磁炉或电热板



1



2



3

YH731GH

ROUND ROLL TOP CHAFING DISH
STAND WITH HOLLOW STEEL LEGS
W/ Φ35CM FOOD PAN 6LTR
W/GOLDEN PLATED
SPEC./产品尺寸:53X48X47CM
MEAS./包装尺寸: 53X53X35CM

圆型镀金全翻盖豪华餐炉
仿铸脚
可配Φ35CM, 6升食物盆

HEAT SOURCE OPTION:

INDUCTION COOKER
ELECTRICAL WARMER
可自由搭配电磁炉或电热板



1



2



3

ROLL TOP CHAFING DISH

YH723D

OBLONG ROLL TOP CHAFING DISH
W/ GN 1/1 FOOD PAN 9.0Ltr
SPEC./产品尺寸:64X49.5X44CM
MEAS./包装尺寸: 75X50X33CM

长方型全翻盖豪华餐炉
可配GN1/1食物盆,9升

DETACHABLE LID

FOR QUICK & EASY CLEANING
炉盖可轻易拆出: 清洗方便

YH728D

OPTIONAL 2X4.5Ltr SOUP BUCKETS
SPEC./产品尺寸:64X49.5X44CM
MEAS./包装尺寸: 75X50X39CM

可配2只4.5升汤桶

YH723D-2

OPTIONAL 2X1/2 FOOD PAN
可配2只1/2食物盆

STAYS OPEN AT 90°

盖子可打开90°

STACKABLE DESIGN

叠式设计, 方便储存

FULLY OPEN AT 180°

盖子可打开180°

HEAT SOURCE OPTION:

INDUCTION COOKER
ELECTRICAL WARMER
可自由搭配电磁炉或电热板



YH721D

ROUND ROLL TOP CHAFING DISH
W/ Ø35CM FOOD PAN 6.0 Ltr
SPEC./产品尺寸:47.5X52X46.5CM
MEAS./包装尺寸: 53X49.5X35CM

圆型全翻盖餐炉
可配Ø35CM, 6升食物盆

YH720D

OPTIONAL 10Ltr SOUP BUCKETS
SPEC./产品尺寸:47.5X52X46.5CM
MEAS./包装尺寸: 53X49.5X39CM
可配10升汤桶

STAYS OPEN AT 90°

盖子可打开90°

FULLY OPEN AT 180°

盖子可打开180°

STACKABLE DESIGN

叠式设计, 方便储存

HEAT SOURCE OPTION:

INDUCTION COOKER
ELECTRICAL WARMER
可自由搭配电磁炉或电热板



ROLL TOP CHAFING DISH

YH722D

2/3 SIZE ROLL TOP CHAFING DISH
W/ GN 2/3 FOOD PAN 6.0Ltr
SPEC./产品尺寸:48.5X47X44.5CM
MEAS./包装尺寸:50X49X33CM

2/3 方型全翻盖豪华餐炉
可配GN2/3食物盆,6.0升

DETACHABLE LID

FOR QUICK & EASY CLEANING
炉盖可轻易拆出: 清洗方便

STAYS OPEN AT 90°

FULLY OPEN AT 180°

盖子可打开90° 或180°

STACKABLE DESIGN

叠式设计, 方便储存



1



2



3



4



5

YH736D

OVAL ROLL TOP CHAFING DISH
W/ 6.8L OVAL FOOD PAN
SPEC./产品尺寸:65X55X46.5CM
MEAS./包装尺寸: 66X56X33CM

椭圆形全翻盖餐炉
可配6.8L食物盆

STAYS OPEN AT 90°

盖子可打开90°

FULLY OPEN AT 180°

盖子可打开180°

STACKABLE DESIGN

叠式设计, 方便储存

HEAT SOURCE OPTION:

INDUCTION COOKER
ELECTRICAL WARMER
可自由搭配电磁炉或电热板



2



3



4



5



6



1

ROLL TOP CHAFING DISH

1 YH723

OBLONG ROLL TOP CHAFING DISH
W/ GN 1/1 FOOD PAN 9.0Ltr
SPEC./产品尺寸:64X49.5X44CM
MEAS./包装尺寸: 75X50X33CM

长方形全翻盖豪华餐炉
可配GN1/1食物盆,9升

2 YH723-2

OPTIONAL 2X1/2 FOOD PAN
可配2只1/2食物盆

3 YH728

OPTIONAL 2X4.5Ltr SOUP BUCKETS
SPEC./产品尺寸:64X49.5X44CM
MEAS./包装尺寸: 75X50X39CM
可配2只4.5升汤桶

4 STAYS OPEN AT 90°

盖子可打开90°

5 FULLY OPEN AT 180°

盖子可打开180°

6 HEAT SOURCE OPTION:

INDUCTION COOKER
ELECTRICAL WARMER
可自由搭配电磁炉或电热板



1 YH721

ROUND ROLL TOP CHAFING DISH
W/ Φ35CM FOOD PAN 6.0 Ltr
SPEC./产品尺寸:47.5X52X46.5CM
MEAS./包装尺寸: 53X49.5X35CM

圆型全翻盖餐炉
可配Φ35CM, 6升食物盆

2 YH720

OPTIONAL 10Ltr SOUP BUCKETS
SPEC./产品尺寸:47.5X52X46.5CM
MEAS./包装尺寸: 53X49.5X39CM
可配10升汤桶

4 STAYS OPEN AT 90°

盖子可打开90°

5 FULLY OPEN AT 180°

盖子可打开180°

6 HEAT SOURCE OPTION:

INDUCTION COOKER
ELECTRICAL WARMER
可自由搭配电磁炉或电热板



ROLL TOP CHAFING DISH



YH722

2/3 SIZE ROLL TOP CHAFING DISH
W/ GN 2/3 FOOD PAN 6.0Ltr
SPEC./产品尺寸:48.5X47X44.5CM
MEAS./包装尺寸:50X49X33CM
2/3 方型全翻盖豪华餐炉
可配GN2/3食物盆,6.0升

DETACHABLE LID

FOR QUICK & EASY CLEANING
炉盖可轻易拆出: 清洗方便

STAYS OPEN AT 90°

FULLY OPEN AT 180°

盖子可打开90° 或180°



YH736

OVAL ROLL TOP CHAFING DISH
W/ 6.8L OVAL FOOD PAN
SPEC./产品尺寸:65X55X46.5CM
MEAS./包装尺寸: 66X56X33CM

椭圆形全翻盖餐炉
可配6.8L食物盆

STAYS OPEN AT 90°

盖子可打开90°

FULLY OPEN AT 180°

盖子可打开180°

HEAT SOURCE OPTION:

INDUCTION COOKER
ELECTRICAL WARMER
可自由搭配电磁炉或电热板



ROLL TOP CHAFING DISH

YH723BGH

OBLONG ROLL TOP CHAFING DISH
W/ GN 1/1 FOOD PAN 9.0Ltr
W/ GOLDEN PLATED
SPEC./产品尺寸:64X49.5X45CM
MEAS./包装尺寸: 76X53X35CM

长方形镀金全翻盖豪华餐炉
可配GN1/1食物盆,9升

YH723BGH-2

OPTIONAL 2X1/2 FOOD PAN
可配2只1/2食物盆

YH728BGH

OPTIONAL 2X4.5Ltr SOUP BUCKETS
SPEC./产品尺寸:64X49.5X45CM
MEAS./包装尺寸: 76X53X39CM
可配2只4.5升汤桶

STAYS OPEN AT 90°

盖子可打开90°

FULLY OPEN AT 180°

盖子可打开180°



1

YH721BGH

ROUND ROLL TOP CHAFING DISH
W/ Φ35CM FOOD PAN 6LTR
W/ GOLDEN PLATED
SPEC./产品尺寸:47.5X52X47CM
MEAS./包装尺寸: 53X49.5X35CM

圆型镀金全翻盖餐炉
可配Φ35CM, 6升食物盆

YH720BGH

OPTIONAL 10Ltr SOUP BUCKETS
SPEC./产品尺寸:47.5X52X47CM
MEAS./包装尺寸: 53X49.5X39CM
可配10升汤桶

STAYS OPEN AT 90°

盖子可打开90°

FULLY OPEN AT 180°

盖子可打开180°



1

ROLL TOP CHAFING DISH

YH722B

2/3 SIZE ROLL TOP CHAFING DISH
W/ GN 2/3 FOOD PAN 6.0Ltr
SPEC./产品尺寸:48.5X47X44.5CM
MEAS./包装尺寸:50X49X34CM

2/3 方型全翻盖豪华餐炉
可配GN2/3食物盆,6.0升

DETACHABLE LID

FOR QUICK & EASY CLEANING
炉盖可轻易拆出: 清洗方便

STAYS OPEN AT 90°

FULLY OPEN AT 180°

盖子可打开90° 或180°



YH736BGH

OVAL ROLL TOP CHAFING DISH
W/ GN 1/1 FOOD PAN 6.8Ltr
W/ GOLDEN PLATED
SPEC./产品尺寸:65X55X47CM
MEAS./包装尺寸: 66X56X33CM

椭圆形镀金全翻盖豪华餐炉
可配6.8L食物盆

STAYS OPEN AT 90°

盖子可打开90°

FULLY OPEN AT 180°

盖子可打开180°



ROLL TOP CHAFING DISH



YH726D

3.0L ROLL TOP CHAFING DISH
W/3.0L FOOD PAN
SPEC./产品尺寸: 41X38X37CM
MEAS./包装尺寸: 39.5X38.5X26CM

圆型全翻盖餐炉
可配3.0L物盆

STACKABLE DESIGN

叠式设计, 方便储存

YH726

3.0L ROLL TOP CHAFING DISH
W/3.0L FOOD PAN
SPEC./产品尺寸: 41X38X37CM
MEAS./包装尺寸: 39.5X38.5X26CM

圆型全翻盖餐炉
可配3.0L物盆



YH723L

OBLONG ROLL TOP CHAFING DISH
W/ SHOW WINDOW
W/ GN1/1 FOOD PAN 9.0Ltr
SPEC./产品尺寸: 64X49.5X44CM
MEAS./包装尺寸: 75X50X33CM

长方形天窗全翻盖豪华餐炉
可视天窗
可配GN1/1食物盆, 9升

STAYS OPEN AT 90°

盖子可打开90°

FULLY OPEN AT 180°

盖子可打开90° 或180°

DETACHABLE LID

FOR QUICK & EASY CLEANING
炉盖可轻易拆出: 清洗方便



ROLL TOP CHAFING DISH



1 YH721L

ROUND ROLL TOP CHAFING DISH
W/ SHOW WINDOW
W/ Φ35CM FOOD PAN 6.0Ltr
SPEC./产品尺寸: 47.5X52X46.5CM
MEAS./包装尺寸: 53X49.5X35CM

圆型天窗全翻盖餐炉
可视天窗
可配Φ35CM, 6升食物盆

2 STAYS OPEN AT 90°

盖子可打开90°

3 FULLY OPEN AT 180°

盖子可打开90° 或180°



2



3



SPRING HINGED CHAFING DISH

YUFEH
Kitchen Ware



1

2 SPRING COVER DESIGN, OPEN COVER
EASILY AND EFFORTLESSLY
弹簧链接技术, 开盖不费力

3 DETACHABLE LID
FOR QUICK & EASY CLEANING
炉盖可轻易拆出: 清洗方便

4 CONVENIENT SHELF TO PLACE A GEL STERNO
新款水盆底部卡槽设计, 可抽出式燃料支撑架,
安装使用更方便



2

3



4

5

SPRING HINGED CHAFING DISH



233

OBLONG SPRING HINGED CHAFING DISH
W/GN 1/1 FOOD PAN 9Ltr
SPEC./产品尺寸: 57X40.5X32CM
MEAS./包装尺寸: 57.5X41X34.5CM

长方形弹簧缓冲式豪华餐炉
可配GN1/1食物盆, 9升

DETACHABLE LID
FOR QUICK & EASY CLEANING
炉盖可轻易拆出: 清洗方便
DOME COVER STOPS AT ANY ANGLE
FOR USE PURPOSES
任意角度停留, 方便顾客用餐

CONVENIENT SHELF TO PLACE A
GEL STERNO
新款水盆底部卡槽设计, 可抽出式燃料支
撑架, 安装使用更方便

HEAT SOURCE OPTION:
STERNO, FUEL, HEATING ELEMENT
可自由搭配固体酒精, 燃料, 电热板



1

SPRING HINGED CHAFING DISH

YUFEH
Kitchen Ware



232

2/3 SIZE SPRING HINGED CHAFING DISH
W/GN 2/3 FOOD PAN 6Ltr
SPEC./产品尺寸: 39.5X40.5X32CM
MEAS./包装尺寸: 41X40X34.5CM

2/3方型弹簧缓冲式豪华餐炉
可配GN2/3食物盆, 6升

DETACHABLE LID
FOR QUICK & EASY CLEANING
炉盖可轻易拆出: 清洗方便

DOME COVER STOPS AT ANY ANGLE
FOR USE PURPOSES
任意角度停留, 方便顾客用餐

CONVENIENT SHELF TO PLACE A GEL
STERNO
新款水盆底部卡槽设计, 可抽出式燃料支
撑架, 安装使用更方便

HEAT SOURCE OPTION:
STERNO, FUEL, HEATING ELEMENT
可自由搭配固体酒精, 燃料, 电热板

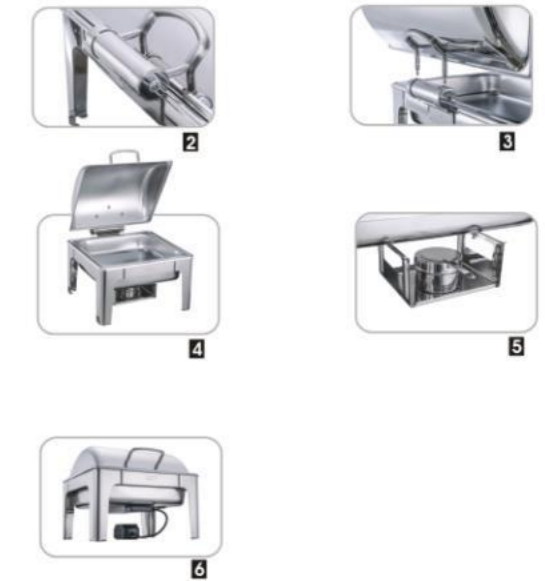

1

SPRING HINGED CHAFING DISH



234

HALF SIZE SPRING HINGED CHAFING DISH
W/GN 1/2 FOOD PAN 4Ltr
SPEC./产品尺寸: 36.5X34.5X32CM
MEAS./包装尺寸: 37X35X34.5CM

½ 方型弹簧缓冲式豪华餐炉
可配GN1/2食物盆,4升

DETACHABLE LID
FOR QUICK & EASY CLEANING
炉盖可轻易拆出: 清洗方便

45

DOME COVER STOPS AT ANY ANGLE
FOR USE PURPOSES
任意角度停留, 方便顾客用餐

CONVENIENT SHELF TO PLACE A GEL
STERNO
新款水盆底部卡槽设计, 可抽出式燃料支撑架, 安装使用更方便

02

HEAT SOURCE OPTION:
STERNO, FUEL, HEATING ELEMENT
可自由搭配固体酒精, 燃料, 电热板



SPRING HINGED CHAFING DISH



231

ROUND SPRING HINGED CHAFING DISH
W/ Φ35CM FOOD PAN, 6Ltr
SPEC./产品尺寸: 42X46X32CM
MEAS./包装尺寸: 43X43X34.5CM

圆型弹簧缓冲式豪华餐炉
可配Φ35CM 6升食物盆

DETACHABLE LID
FOR QUICK & EASY CLEANING
炉盖可轻易拆出: 清洗方便

DOME COVER STOPS AT ANY ANGLE
FOR USE PURPOSES
任意角度停留, 方便顾客用餐

CONVENIENT SHELF TO PLACE A
GEL STERNO
新款水盆底部卡槽设计, 可抽出式燃料支撑架, 安装使用更方便

HEAT SOURCE OPTION:
STERNO, FUEL, HEATING ELEMENT
可自由搭配固体酒精, 燃料, 电热板

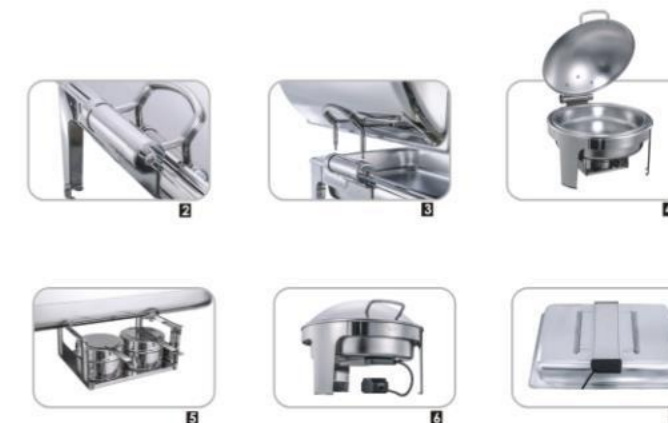

SPRING HINGED CHAFING DISH



230

ROUND SOUP STATION
W/ 10L SOUP BUCKET
SPEC./产品尺寸: 42X42X38CM
MEAS./包装尺寸: 43X43X36CM
圆型豪华汤炉

可配10L汤桶



1

224

OPTIONAL 2X4.5Ltr ROUP BUCKETS
SPEC./产品尺寸: 57X40.5X34CM
MEAS./包装尺寸: 57.5X41X33CM
方形豪华汤炉

可配2只4.5升汤桶



3

4

5

6

10L SOUP BUCKET
10升汤桶

2X4.5L SOUP BUCKETS
2只4.5升汤桶

CONVENIENT SHELF TO PLACE A GEL STERNO
新款水盆底部卡槽设计, 可抽出式燃料支撑架, 安装使用更方便

HEAT SOURCE OPTION:
STERNO, FUEL, HEATING ELEMENT
可自由搭配固体酒精, 燃料, 电热板



2

SPRING HINGED CHAFING DISH



210

OPTIONAL 2X 10" STEAMER
SPEC./产品尺寸: 42X42X43CM
MEAS./包装尺寸: 43X43X40CM
圆形豪华蒸炉

可配2只10"蒸笼



3

4

228

OPTIONAL 4X 8" STEAMER
SPEC./产品尺寸: 57X40.5X42.5CM
MEAS./包装尺寸: 57.5X41X39.5CM
方形豪华蒸炉

可配4只8"蒸笼



3

4

10" STEAMER
10寸蒸笼

8" STEAMER
8寸蒸笼

CONVENIENT SHELF TO PLACE A GEL STERNO
新款水盆底部卡槽设计, 可抽出式燃料支撑架, 安装使用更方便

HEAT SOURCE OPTION:
STERNO, FUEL, HEATING ELEMENT
可自由搭配固体酒精, 燃料, 电热板



2

SPRING HINGED CHAFING DISH



1

12 SPRING COVER DESIGN, OPEN COVER EASILY AND EFFORTLESSLY
 弹簧链接技术, 开盖不费力
 只需将盖子轻轻抬起, 便自动弹起。

3 DETACHABLE LID FOR QUICK & EASY CLEANING
 炉盖可轻易拆出: 清洗方便

45 CONVENIENT SHELF TO PLACE A GEL STERNO
 新款水盆底部卡槽设计, 可抽出式燃料支撑架, 安装使用更方便



SPRING HINGED CHAFING DISH



233S

OBLONG SPRING HINGED CHAFING DISH
 W/GN 1/1 FOOD PAN 9Ltr
 SPEC./产品尺寸: 57X43X29CM
 MEAS./包装尺寸: 57.5X43X31CM

长方形弹簧缓冲式豪华餐炉
 可配GN1/1食物盆

DETACHABLE LID FOR QUICK & EASY CLEANING
 炉盖可轻易拆出: 清洗方便

DOME COVER STOPS AT ANY ANGLE FOR USE PURPOSES
 任意角度停留, 方便顾客用餐

5 CONVENIENT SHELF TO PLACE A GEL STERNO
 新款水盆底部卡槽设计, 可抽出式燃料支撑架, 安装使用更方便

67 HEAT SOURCE OPTION: STERNO, FUEL, HEATING ELEMENT
 可自由搭配固体酒精, 燃料, 电热板



1



SPRING HINGED CHAFING DISH

**NEW
新品**

232S

2/3 SIZE SPRING HINGED CHAFING DISH
W/GN 2/3 FOOD PAN 6Ltr
SPEC./产品尺寸: 39.5X43X29CM
MEAS./包装尺寸: 43X40X30.5CM

2/3方型弹簧缓冲式豪华餐炉
可配GN2/3食物盆,6升

DETACHABLE LID
FOR QUICK & EASY CLEANING
炉盖可轻易拆出: 清洗方便

DOME COVER STOPS AT ANY ANGLE
FOR USE PURPOSES
任意角度停留, 方便顾客用餐

CONVENIENT SHELF TO PLACE A
GEL STERNO
新款水盆底部卡槽设计, 可抽出式燃料
支撑架, 安装使用更方便

HEAT SOURCE OPTION:
STERNO, FUEL HEATING ELEMENT
可自由搭配固体酒精, 燃料, 电热板



**NEW
新品**

234S

HALF SIZE SPRING HINGED CHAFING DISH
W/GN 1/2 FOOD PAN 4Ltr
SPEC./产品尺寸: 36.5X37X28CM
MEAS./包装尺寸: 37X37X30CM

1/2 方型弹簧缓冲式豪华餐炉
可配GN1/2食物盆,4升

DETACHABLE LID
FOR QUICK & EASY CLEANING
炉盖可轻易拆出: 清洗方便

DOME COVER STOPS AT ANY ANGLE
FOR USE PURPOSES
任意角度停留, 方便顾客用餐

CONVENIENT SHELF TO PLACE A
GEL STERNO
新款水盆底部卡槽设计, 可抽出式燃料
支撑架, 安装使用更方便

HEAT SOURCE OPTION:
STERNO, FUEL HEATING ELEMENT
可自由搭配固体酒精, 燃料, 电热板

SPRING HINGED CHAFING DISH

YUFEH
Kitchen Ware



SPRING HINGED CHAFING DISH

**NEW
新品**

231S

ROUND SPRING HINGED CHAFING DISH
W/ Ø35CM FOOD PAN, 6Ltr
SPEC./产品尺寸: 46.5X42X32CM
MEAS./包装尺寸: 43X43X34.5CM

圆型弹簧缓冲式豪华餐炉
可配Ø35CM 6升食物盆

DETACHABLE LID
FOR QUICK & EASY CLEANING
炉盖可轻易拆出: 清洗方便

DOMED COVER STOPS AT ANY ANGLE
FOR USE PURPOSES
任意角度停留, 方便顾客用餐

CONVENIENT SHELF TO PLACE A
GEL STERNO
新款水盆底部卡槽设计, 可抽出式燃料
支撑架, 安装使用更方便

HEAT SOURCE OPTION:
STERNO, FUEL, HEATING ELEMENT
可自由搭配固体酒精, 燃料, 电热板



1



2



3



4



5



6



7

**NEW
新品**

230S

ROUND SOUP STATION
W/ 10L SOUP BUCKET
SPEC./产品尺寸: 42X42X38CM
MEAS./包装尺寸: 43X43X36CM

圆型豪华汤炉
可配10L汤桶

224S

OPTIONAL 2X4.5Ltr ROUP BUCKETS
SPEC./产品尺寸: 57X40.5X34CM
MEAS./包装尺寸: 57.5X41X33CM

可配2只4.5升汤桶

CONVENIENT SHELF TO PLACE A
GEL STERNO
新款水盆底部卡槽设计, 可抽出式燃料
支撑架, 安装使用更方便

HEAT SOURCE OPTION:
STERNO, FUEL, HEATING ELEMENT
可自由搭配固体酒精, 燃料, 电热板

SPRING HINGED CHAFING DISH | **YUFEH**
Kitchen Ware



1



3



4



5

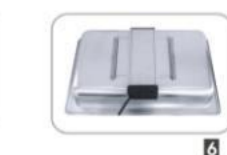

6



2

SPRING HINGED CHAFING DISH



210S

OPTIONAL 2X 10" STEAMER
SPEC./产品尺寸: 42X42X43CM
MEAS./包装尺寸: 43X43X40CM

可配2只10"蒸笼

228S

OPTIONAL 4X 8" STEAMER
SPEC./产品尺寸: 57X40.5X42.5CM
MEAS./包装尺寸: 57.5X41X39.5CM

可配4只8"蒸笼

CONVENIENT SHELF TO PLACE A GEL STERNO

新款水盆底部卡槽设计, 可抽出式燃料支撑架, 安装使用更方便

HEAT SOURCE OPTION:
STERNO, FUEL HEATING ELEMENT
可自由搭配固体酒精, 燃料, 电热板

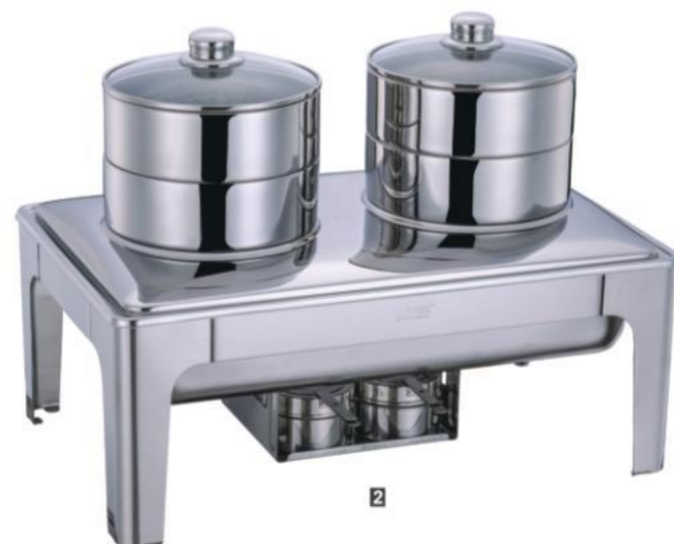

T333

OBLONG CHAFING DISH
方型自助餐炉
CAP./规格: 9L
SPEC./产品尺寸: 62.5X35X34CM
MEAS./包装尺寸: 65X36X24CM



533

OBLONG CHAFING DISH
方型自助餐炉
CAP./规格: 9L
SPEC./产品尺寸: 60X35X33CM
MEAS./包装尺寸: 65X36X24CM



033

OBLONG CHAFING DISH
方型自助餐炉
CAP./规格: 9L
SPEC./产品尺寸: 64X35X33CM
MEAS./包装尺寸: 65X36X24CM



333

OBLONG CHAFING DISH
方型自助餐炉
CAP./规格: 9L
SPEC./产品尺寸: 60X35X34CM
MEAS./包装尺寸: 65X36X24CM



Quality
chafing dish



1

033W

OBLONG CHAFING DISH
方型自助餐炉
CAP./规格: 9L
SPEC./产品尺寸: 64X35X34CM
MEAS./包装尺寸: 65X36X24CM

T033

OBLONG CHAFING DISH
方型自助餐炉
CAP./规格: 9L
SPEC./产品尺寸: 64X35X33CM
MEAS./包装尺寸: 65X36X24CM

633W

OBLONG CHAFING DISH/
方型自助餐炉
CAP./规格: 9L
SPEC./产品尺寸: 61X35X36CM
MEAS./包装尺寸: 62X36X25

634W

HALF SIZE CHAFING DISH
方型自助餐炉
CAP./规格: 4L
SPEC./产品尺寸: 40.5X28X32.5
MEAS./包装尺寸: 41X29X26CM



2



3



4

033+900

OBLONG CHAFING DISH
方型自助餐炉
CAP./规格: 9L
SPEC./产品尺寸: 64X35X40.5CM
MEAS./包装尺寸: 65X36X43CM

333+900

OBLONG CHAFING DISH
方型自助餐炉
CAP./规格: 9L
SPEC./产品尺寸: 60X35X40.5CM
MEAS./包装尺寸: 62X35X43CM

633+900

OBLONG CHAFING DISH
方型自助餐炉
CAP./规格: 9L
SPEC./产品尺寸: 60X35X40.5CM
MEAS./包装尺寸: 61X36X43CM



1



2



3



T333+900

OBLONG CHAFING DISH
方型自助餐炉
CAP./规格: 9L
SPEC./产品尺寸: 62.5X35X40.5
MEAS./包装尺寸: 62X35X43CM

533+900

OBLONG CHAFING DISH
方型自助餐炉
CAP./规格: 9L
SPEC./产品尺寸: 60X35X40.5CM
MEAS./包装尺寸: 62X35X43CM

T033+900

OBLONG CHAFING DISH
方型自助餐炉
CAP./规格: 9L
SPEC./产品尺寸: 64X35X40.5CM
MEAS./包装尺寸: 65X36X43CM

1



2



3

933+W900

OBLONG CHAFING DISH
方型自助餐炉
CAP./规格: 9L
SPEC./产品尺寸: 62.5X37X39CM
MEAS./包装尺寸: 63.5X36X40.5CM

1933+W900

OBLONG CHAFING DISH
方型自助餐炉
CAP./规格: 9L
SPEC./产品尺寸: 65X37X39CM
MEAS./包装尺寸: 66.5X36X40.5CM

Smooth rolling cover opens a full 90°

to allow easy access
半翻盖可开启最大角度为90°

Smooth rolling cover opens a full 90°

to allow easy access
半翻盖可开启最大角度为90°



1



3



4



2

Economic chafing dish



433
OBLONG CHAFING DISH
方型自助餐炉
CAP./规格: 9L
SPEC./产品尺寸:60x35x32cm
MEAS./包装尺寸: 61x36x24cm

T433
OBLONG CHAFING DISH
方型自助餐炉
CAP./规格: 9L
SPEC./产品尺寸:60x35x32cm
MEAS./包装尺寸: 61x36x24cm

JQ433
OBLONG CHAFING DISH
方型自助餐炉
CAP./规格: 9L
SPEC./产品尺寸:61.5x35x33CM
MEAS./包装尺寸: 63X36X26CM

PH433
OBLONG CHAFING DISH
方型自助餐炉
CAP./规格: 9L
SPEC./产品尺寸:60x35x32cm
MEAS./包装尺寸: 61x36x24cm



JQ433C
OBLONG CHAFING DISH
方型自助餐炉
CAP./规格: 9L
SPEC./产品尺寸:61.5x35x33CM
MEAS./包装尺寸: 63X36X26CM

STACKABLE FRAME
可叠式脚架示意图

TJQ433
OBLONG CHAFING DISH
方型自助餐炉
CAP./规格: 9L
SPEC./产品尺寸:62.5X35X31.5
MEAS./包装尺寸: 63.5X36X24CM





JQ433A

OBLONG CHAFING DISH
方型自助餐炉
CAP./规格: 9L
SPEC./产品尺寸: 61.5X35X33
MEAS./包装尺寸: 63X36X26CM

JQ433B

OBLONG CHAFING DISH
方型自助餐炉
CAP./规格: 9L
SPEC./产品尺寸: 58X35X33CM
MEAS./包装尺寸: 60X36X27.5CM



823

OBLONG CHAFING DISH
W/ GN 1/1 FOOD PAN 9.0Ltr
SPEC./产品尺寸: 62X36.5X32
MEAS./包装尺寸: 63X37.5X29CM

长方形不锈钢高级餐炉
可配GN1/1食物盆, 9升

823-2

OPTIONAL 2X1/2 FOOD PAN
可配2只1/2食物盆

828

OPTIONAL 2X4.5Ltr SOUP BUCKETS
可配2只4.5升汤桶

C833

OBLONG CHAFING DISH
方型自助餐炉
CAP./规格: 9L
SPEC./产品尺寸: 63x35x32cm
MEAS./包装尺寸: 64x36x24.5cm

833B

OBLONG CHAFING DISH
方型自助餐炉
CAP./规格: 9L
SPEC./产品尺寸: 64x35x32cm
MEAS./包装尺寸: 65x36x24.5cm

COVER HOLDER

线柄盖挂勾

STACKABLE FRAME

可叠式脚架示意图



Economic chafing dish



1 633

OBLONG CHAFING DISH
方型自助餐炉
CAP./规格: 9L
SPEC./产品尺寸: 60x35x32cm
MEAS./包装尺寸: 61X36X25cm

2 638

OBLONG SOUP STATION
方型自助汤炉
CAP./规格: 2X4L
SPEC./产品尺寸: 60x35x35.5cm
MEAS./包装尺寸: 61X36X30.5CM
W/2X4L SOUP BUCKET 配2x4L汤桶

3 ADAPTOR PLATES

固定罩

4 833

OBLONG CHAFING DISH
方型自助餐炉
CAP./规格: 9L
SPEC./产品尺寸: 63x35x32cm
MEAS./包装尺寸: 64x36x24.5cm

5 838

OBLONG SOUP STATION
方型自助汤炉
CAP./规格: 2X4L
SPEC./产品尺寸: 63x35x35.5cm
MEAS./包装尺寸: 64X36X30.5CM
W/2X4L SOUP BUCKET 配2x4L汤桶

6 ADAPTOR PLATES

固定罩



2



4



3



6



5

1 JQ533

OBLONG CHAFING DISH W
FOLDABLE FRAME
方型折脚自助餐炉
CAP./规格: 9L
SPEC./产品尺寸: 57X35X31.5CM
MEAS./包装尺寸: 58x36x17cm

2 FOLDABLE FRAME DESIGN

折脚设计, 方便储存

3 JQ833

OBLONG CHAFING DISH
方型自助餐炉
CAP./规格: 9L
SPEC./产品尺寸: 63X36X28CM
MEAS./包装尺寸: 64X37X29.5CM

4 Complete with built-in cover holder
designed for convenient storage

配铰链式盖设计



1



2



4



5



3

Economic chafing dish



JQ434B

HALF SIZE CHAFING DISH
1/2方型自助餐炉
CAP./规格: 4.0L
SPEC./产品尺寸: 38X29.5X33CM
MEAS./包装尺寸: 40X31X27.5CM

834

HALF SIZE CHAFING DISH
1/2方型自助餐炉
CAP./规格: 4.0L
SPEC./产品尺寸: 43X30X32CM
MEAS./包装尺寸: 44X31X26CM

834B

HALF SIZE CHAFING DISH
1/2方型自助餐炉
CAP./规格: 4.0L
SPEC./产品尺寸: 43X30X32CM
MEAS./包装尺寸: 44X31X26CM

STACKABLE FRAME

可叠式脚架示意图

8313

1/3 SIZE CHAFING DISH
1/3方型自助餐炉
CAP./规格: 1/3X65MM
SPEC./产品尺寸: 43.5X21X31CM
MEAS./包装尺寸: 44X22X26CM

JQ834

HALF SIZE CHAFING DISH
1/2方型自助餐炉
CAP./规格: 4.0L
SPEC./产品尺寸: 43X30X28CM
MEAS./包装尺寸: 44X32X29.5CM

Complete with built-in cover holder designed for convenient storage

配铰链式盖设计



836B

OVAL CHAFING DISH
加大椭圆型自助餐炉
CAP./规格: 6.8L
SPEC./产品尺寸: 62.5x41x31cm
MEAS./包装尺寸: 63x43x26cm

836LB

OVAL CHAFING DISH
椭圆型自助餐炉
CAP./规格: 5.5L
SPEC./产品尺寸: 56x30.5x28cm
MEAS./包装尺寸: 54x32.5x25cm

C836

OVAL CHAFING DISH
椭圆型自助餐炉
CAP./规格: 5.5L
SPEC./产品尺寸: 56x30.5x28cm
MEAS./包装尺寸: 54x32.5x25cm

836

OVAL CHAFING DISH
椭圆型自助餐炉
CAP./规格: 5.5L
SPEC./产品尺寸: 56x30.5x28cm
MEAS./包装尺寸: 54x32.5x25cm



Economic chafing dish



1



2



3



4



5



1



2



3



4

831-GL

ROUND CHAFING DISH
圆型自助餐炉
W/GLASS LID 配玻璃盖
CAP./规格: 3.5L
SPEC./产品尺寸: 42x34x30cm
MEAS./包装尺寸: 36x36x25cm

831L-GL

ROUND CHAFING DISH
圆型自助餐炉
W/GLASS LID 配玻璃盖
CAP./规格: 5.0L
SPEC./产品尺寸: 42x34x30cm
MEAS./包装尺寸: 36x36x26cm

835-GL

ROUND CHAFING DISH
圆型自助餐炉
W/GLASS LID 配玻璃盖
CAP./规格: 7.5L
SPEC./产品尺寸: 42x34x33cm
MEAS./包装尺寸: 36x36x28cm



5



831

ROUND CHAFING DISH
圆型自助餐炉
CAP./规格: 3.5L
SPEC./产品尺寸: 42x34x30cm
MEAS./包装尺寸: 36x36x25cm

831L

ROUND CHAFING DISH
圆型自助餐炉
CAP./规格: 5.0L
SPEC./产品尺寸: 42x34x30cm
MEAS./包装尺寸: 36x36x26cm

431

ROUND CHAFING DISH
圆型自助餐炉
CAP./规格: 3.5L
SPEC./产品尺寸: 36x34x27.5cm
MEAS./包装尺寸: 34x34x24cm

835

ROUND CHAFING DISH
圆型自助餐炉
CAP./规格: 7.5L
SPEC./产品尺寸: 42x34x33cm
MEAS./包装尺寸: 36x36x28cm

H835

ROUND CHAFING DISH
圆型自助餐炉
CAP./规格: 13.5L
SPEC./产品尺寸: 42x34x40cm
MEAS./包装尺寸: 36x36x37cm

Economic chafing dish



8304BM

ROUND SOUP MARMITE
圓型自助湯爐

CAP./規格: 4.0L
SPEC./產品尺寸: 31.5x23.5x33cm
MEAS./包裝尺寸: 26x26x35cm



8307BM

ROUND SOUP MARMITE
圓型自助湯爐

CAP./規格: 7.0L
SPEC./產品尺寸: 31x24x32
MEAS./包裝尺寸: 26x26x34cm



8311BM

ROUND SOUP MARMITE
圓型自助湯爐

CAP./規格: 11.0L
SPEC./產品尺寸: 36x29x33
MEAS./包裝尺寸: 30x30x35cm

VF834GH

HALF SIZE GOLD ACCENTED
CHAFING DISH
1/2方型鍍金自助餐爐

CAP./規格: 4.0L
SPEC./產品尺寸: 40X29.5X30.5
MEAS./包裝尺寸: 41X31X28.5



VF833GH

OBLONG GOLD ACCENTED
CHAFING DISH
方型鍍金自助餐爐

CAP./規格: 9L
SPEC./產品尺寸: 57X44X32.5CM
MEAS./包裝尺寸: 61X36X26.5CM



VD834GH

HALF SIZE GOLD ACCENTED
CHAFING DISH
1/2方型鍍金自助餐爐

CAP./規格: 4.0L
SPEC./產品尺寸: 41X29.5X30.5
MEAS./包裝尺寸: 42.5X31X28.5



VD833GH

OBLONG GOLD ACCENTED
CHAFING DISH
方型鍍金自助餐爐

CAP./規格: 9L
SPEC./產品尺寸: 62X43.5X35.5CM
MEAS./包裝尺寸: 63X36X28CM



Economic chafing dish



VF831GH

ROUND GOLD ACCENTED
CHAFING DISH
圆型镀金自助餐炉

CAP./规格: 3.5L
SPEC./产品尺寸: 38.5X38.5X29.5CM
MEAS./包装尺寸: 35X35X25.5CM

VF839GH

ROUND GOLD ACCENTED
CHAFING DISH
圆型镀金自助餐炉

CAP./规格: 6.0L
SPEC./产品尺寸: 44X44X35cm
MEAS./包装尺寸: 39X39X34cm

VD831GH

ROUND GOLD ACCENTED
CHAFING DISH
圆型镀金自助餐炉

CAP./规格: 3.5L
SPEC./产品尺寸: 40X32.5X38.5CM
MEAS./包装尺寸: 41X34.5X25CM

VD839GH

ROUND GOLD ACCENTED
CHAFING DISH
圆型镀金自助餐炉

CAP./规格: 6.0L
SPEC./产品尺寸: 44X38X33cm
MEAS./包装尺寸: 45X39X34cm



VF8304GH

ROUND GOLD ACCENTED
SOUP MARMITE
圆型镀金自助汤炉

CAP./规格: 4.0L
SPEC./产品尺寸: 28.5X28.5X40.5cm
MEAS./包装尺寸: 26X26X36cm

VD8304GH

ROUND GOLD ACCENTED
SOUP MARMITE
圆型镀金自助汤炉

CAP./规格: 4.0L
SPEC./产品尺寸: 30X26X40.5cm
MEAS./包装尺寸: 31X27X36cm

VF8307GH

ROUND GOLD ACCENTED
SOUP MARMITE
圆型镀金自助汤炉

CAP./规格: 7.0L
SPEC./产品尺寸: 28.5X28.5X40.5cm
MEAS./包装尺寸: 26X26X36cm

VD8307GH

ROUND GOLD ACCENTED
SOUP MARMITE
圆型镀金自助汤炉

CAP./规格: 7.0L
SPEC./产品尺寸: 30X26X40.5cm
MEAS./包装尺寸: 31X27X36cm

VF8311GH

ROUND GOLD ACCENTED
COFFEE URN
圆型镀金咖啡炉

CAP./规格: 11L
SPEC./产品尺寸: 32.5X33X49cm
MEAS./包装尺寸: 33X30X44cm

VD8311GH

ROUND GOLD ACCENTED
COFFEE URN
圆型镀金咖啡炉

CAP./规格: 11L
SPEC./产品尺寸: 34X31.5X49cm
MEAS./包装尺寸: 34X33X44.5cm



Economic chafing dish



833P

OBLONG CHAFING DISH
方型自助餐炉
CAP./规格: 9L
SPEC./产品尺寸: 65X36X35.5CM
MEAS./包装尺寸: 66X37X26CM

V834

HALF SIZE CHAFING DISH
1/2方型自助餐炉
CAP./规格: 4.0L
SPEC./产品尺寸: 39X30X33CM
MEAS./包装尺寸: 40X31X29CM

V833

OBLONG CHAFING DISH
方型自助餐炉
CAP./规格: 9L
SPEC./产品尺寸: 59X35X35cm
MEAS./包装尺寸: 60X36X29cm



5.0GL TEA DISPENSER

5.0加伦圆形茶桶
CAP./规格: 5.0GL
SPEC./产品尺寸: 35X31.5X68.5CM
MEAS./包装尺寸: 30X30X70CM

3.5GL TEA DISPENSER

3.5加伦圆形茶桶
CAP./规格: 3.5GL
SPEC./产品尺寸: 35X31.5X56.5CM
MEAS./包装尺寸: 30X30X57CM

TWIN BEVERAGE DISPENSER

2.0加伦方形茶桶
CAP./规格: 2.0GL
SPEC./产品尺寸: 54X18.2X37.5CM
MEAS./包装尺寸: 56x19x38cm



Trolley



1

T20020

2 TIERS TROLLEY
SPEC./产品尺寸:85.5X53.5X94CM
MEAS./包装尺寸: 85X54X14CM



2

T20030

3 TIERS TROLLEY
SPEC./产品尺寸:85.5X53.5X94CM
MEAS./包装尺寸: 85X54X21CM

Gastronorm Pan

YUFEH[®]
Kitchen Ware



Gastronorm Pan

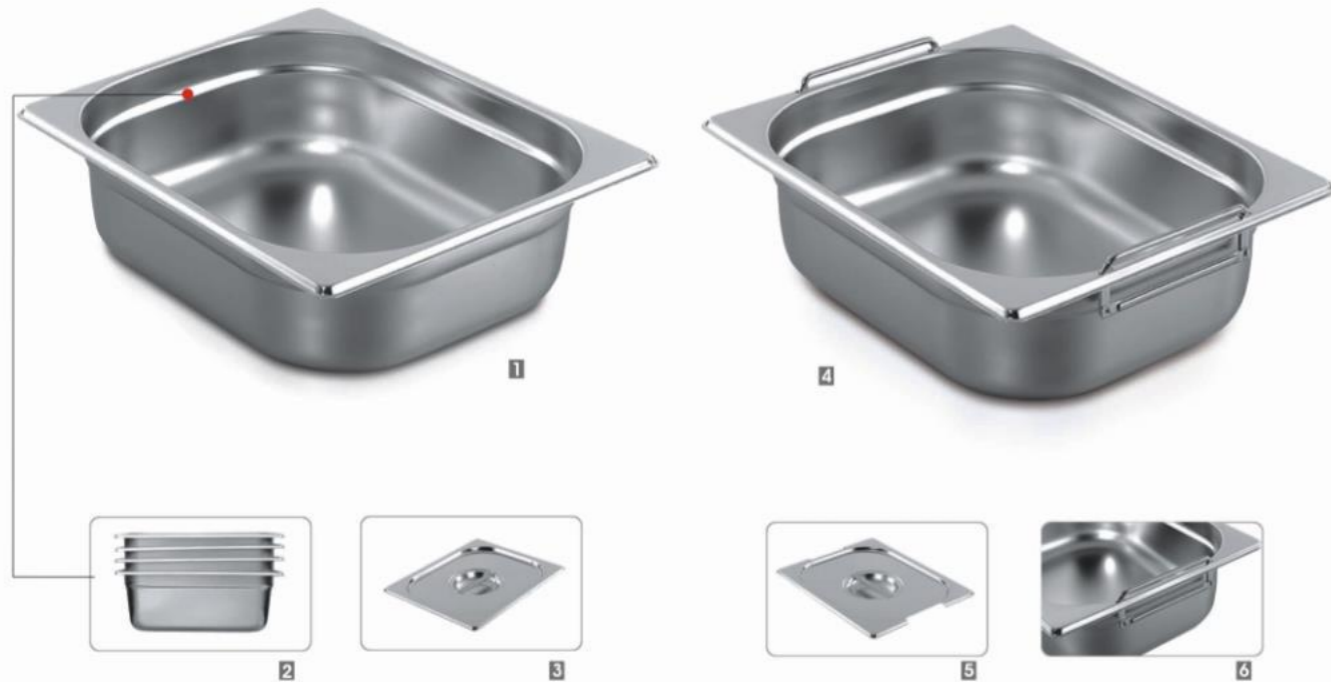

Pan Layouts

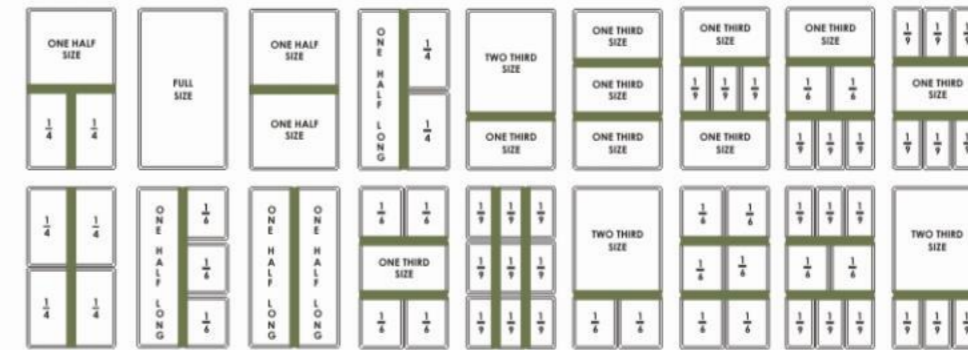

1 EUROPE GASTRONORM PAN

ACCORD WITH EN-631 STANDARD
欧式不锈钢份数盆
产品符合EN-631标准

2 STACKING & ANTI-JAM FUNCTION

STACKABLE,
PREVENT JAMMING DURING STORAGE,
EASY TO TAKE OUT
盆身防挤设计
在叠放时,防止盆与盆之间吸住,方便使用

3 ADDITIONAL HANDLE

CONVENIENCE USE
伸缩式手柄
在使用中更方便



ART NO. 货号	SIZE(MM) 产品规格(MM)	THICKNESS(MM) 厚度(MM)	SPEC.(MM) 产品尺码(MM)	MEAS.(MM) 包装尺码(MM)	PCS/CTNS 每箱数量
821-20	GN2/1X20	0.8	650X530X20	660X545X70	6
821-40	GN2/1X40	0.8	650X530X40	660X545X100	6
821-55	GN2/1X55	0.8	650X530X55	660X545X130	6
821-2	GN2/1X65	0.8	650X530X65	660X545X130	6
821-4	GN2/1X100	0.8	650X530X100	660X545X250	6
821-6	GN2/1X150	0.8	650X530X150	660X545X310	6
821-8	GN2/1X200	0.8	650X530X200	660X545X360	6

ART NO. 货号	SIZE(MM) 产品规格(MM)	THICKNESS(MM) 厚度(MM)	SPEC.(MM) 产品尺码(MM)	MEAS.(MM) 包装尺码(MM)	PCS/CTNS 每箱数量
811-20	GN1/1X20	0.6	530X325X20	550X340X50	6
811-40	GN1/1X40	0.6	530X325X40	550X340X90	6
811-55	GN1/1X55	0.6	530X325X55	550X340X110	6
811-2	GN1/1X65	0.6	530X325X65	550X340X110	6
811-4	GN1/1X100	0.6	530X325X100	550X340X240	6
811-6	GN1/1X150	0.7	530X325X150	550X340X280	6
811-8	GN1/1X200	0.7	530X325X200	550X340X340	6

Gastronorm Pan



ART NO. 货号	SIZE(MM) 产品规格(MM)	THICKNESS(MM) 厚度(MM)	SPEC.(MM) 产品尺码(MM)	MEAS.(MM) 包装尺码(MM)	PCS/CTNS 每箱数量
812-20	GN1/2X20	0.6	325x265X20	570X350X70	12
812-40	GN1/2X40	0.6	325x265X40	570X350X110	12
812-55	GN1/2X55	0.6	325x265X55	570X350X140	12
812-2	GN1/2X65	0.6	325x265X65	570X350X140	12
812-4	GN1/2X100	0.6	325x265X100	570X350X260	12
812-6	GN1/2X150	0.7	325x265X150	570X350X310	12
812-8	GN1/2X200	0.7	325x265X200	570X350X360	12



1

ART NO. 货号	SIZE(MM) 产品规格(MM)	THICKNESS(MM) 厚度(MM)	SPEC.(MM) 产品尺码(MM)	MEAS.(MM) 包装尺码(MM)	PCS/CTNS 每箱数量
813-20	GN1/3X20	0.6	325x176X20	570X350X70	18
813-40	GN1/3X40	0.6	325x176X40	570X350X110	18
813-55	GN1/3X55	0.6	325x176X55	570X350X140	18
813-2	GN1/3X65	0.6	325x176X65	570X350X140	18
813-4	GN1/3X100	0.6	325x176X100	570X350X260	18
813-6	GN1/3X150	0.7	325x176X150	570X350X310	18
813-8	GN1/3X200	0.7	325x176X200	570X350X360	18



2

ART NO. 货号	SIZE(MM) 产品规格(MM)	THICKNESS(MM) 厚度(MM)	SPEC.(MM) 产品尺码(MM)	MEAS.(MM) 包装尺码(MM)	PCS/CTNS 每箱数量
814-20	GN1/4X20	0.6	265x162X20	570X350X70	24
814-40	GN1/4X40	0.6	265x162X40	570X350X110	24
814-55	GN1/4X55	0.6	265x162X55	570X350X140	24
814-2	GN1/4X65	0.6	265x162X65	570X350X140	24
814-4	GN1/4X100	0.6	265x162X100	570X350X260	24
814-6	GN1/4X150	0.7	265x162X150	570X350X310	24
814-8	GN1/4X200	0.7	265x162X200	570X350X360	24



3

ART NO. 货号	SIZE(MM) 产品规格(MM)	THICKNESS(MM) 厚度(MM)	SPEC.(MM) 产品尺码(MM)	MEAS.(MM) 包装尺码(MM)	PCS/CTNS 每箱数量
816-2	GN1/6X65	0.6	176x162X65	570X350X140	36
816-4	GN1/6X100	0.6	176x162X100	570X350X260	36
816-6	GN1/6X150	0.7	176x162X150	570X350X310	36
816-8	GN2/1X200	0.7	176x162X200	570X350X360	36



4



1

ART NO. 货号	SIZE(MM) 产品规格(MM)	THICKNESS(MM) 厚度(MM)	SPEC.(MM) 产品尺码(MM)	MEAS.(MM) 包装尺码(MM)	PCS/CTNS 每箱数量
819-2	GN1/9X65	0.6	176x108X65	480X380X140	48
819-4	GN1/9X100	0.7	176x108X100	480X380X260	48
819-6	GN1/9X150	0.7	176x108X150	480X380X310	48

ART NO. 货号	SIZE(MM) 产品规格(MM)	THICKNESS(MM) 厚度(MM)	SPEC.(MM) 产品尺码(MM)	MEAS.(MM) 包装尺码(MM)	PCS/CTNS 每箱数量
823-20	GN2/3X20	0.6	353x325X20	680X375X70	12
823-40	GN2/3X40	0.6	353x325X40	680X375X110	12
823-55	GN2/3X55	0.6	353x325X55	680X375X140	12
823-2	GN2/3X65	0.6	353x325X65	680X375X140	12
823-4	GN2/3X100	0.6	353x325X100	680X375X260	12
823-6	GN2/3X150	0.7	353x325X150	680X375X310	12
823-8	GN2/3X200	0.7	353x325X200	680X375X360	12



2

ART NO. 货号	SIZE(MM) 产品规格(MM)	THICKNESS(MM) 厚度(MM)	SPEC.(MM) 产品尺码(MM)	MEAS.(MM) 包装尺码(MM)	PCS/CTNS 每箱数量
824-20	GN2/4X20	0.6	530x162X20	570X360X70	12
824-40	GN2/4X40	0.6	530x162X40	570X360X110	12
824-2	GN2/4X65	0.6	530x162X65	570X360X260	24
824-4	GN2/4X100	0.6	530x162X100	570X550X260	18
824-6	GN2/4X150	0.7	530x162X150	570X360X310	12



3

ART NO. 货号	SIZE(MM) 产品规格(MM)	THICKNESS(MM) 厚度(MM)	SPEC.(MM) 产品尺码(MM)	MEAS.(MM) 包装尺码(MM)	PCS/CTNS 每箱数量
8112-2	GN1/12X65	0.6	132x108X65	450X260X170	36
8112-4	GN1/12X100	0.7	132x108X100	450X260X260	36



4

Gastronorm Pan

EUROPE PERFORATED GASTRONORM PAN

HOLE DIA.:5mm
欧式打孔不锈钢份数盆
打孔直径: 5mm

ART NO. 货号	SIZE(MM) 产品规格(MM)	THICKNESS(MM) 厚度(MM)	SPEC.(MM) 产品尺码(MM)	MEAS.(MM) 包装尺码(MM)	PCS/CTNS 每箱数量
821-20P	GN2/1X20	0.8	650X530X20	660X545X70	6
821-40P	GN2/1X40	0.8	650X530X40	660X545X100	6
821-55P	GN2/1X55	0.8	650X530X55	660X545X130	6
821-2P	GN2/1X65	0.8	650X530X65	660X545X130	6
821-4P	GN2/1X100	0.8	650X530X100	660X545X250	6
821-6P	GN2/1X150	0.8	650X530X150	660X545X310	6
821-8P	GN2/1X200	0.8	650X530X200	660X545X360	6



1



1

ART NO. 货号	SIZE(MM) 产品规格(MM)	THICKNESS(MM) 厚度(MM)	SPEC.(MM) 产品尺码(MM)	MEAS.(MM) 包装尺码(MM)	PCS/CTNS 每箱数量
811-20P	GN1/1X20	0.6	530X325X20	550X340X50	6
811-40P	GN1/1X40	0.6	530X325X40	550X340X90	6
811-55P	GN1/1X55	0.6	530X325X55	550X340X110	6
811-2P	GN1/1X65	0.6	530X325X65	550X340X110	6
811-4P	GN1/1X100	0.6	530X325X100	550X340X240	6
811-6P	GN1/1X150	0.7	530X325X150	550X340X280	6
811-8P	GN1/1X200	0.7	530X325X200	550X340X340	6



2



2

ART NO. 货号	SIZE(MM) 产品规格(MM)	THICKNESS(MM) 厚度(MM)	SPEC.(MM) 产品尺码(MM)	MEAS.(MM) 包装尺码(MM)	PCS/CTNS 每箱数量
812-20P	GN1/2X20	0.6	325x265X20	570X350X70	12
812-40P	GN1/2X40	0.6	325x265X40	570X350X110	12
812-55P	GN1/2X55	0.6	325x265X55	570X350X140	12
812-2P	GN1/2X65	0.6	325x265X65	570X350X140	12
812-4P	GN1/2X100	0.6	325x265X100	570X350X260	12
812-6P	GN1/2X150	0.7	325x265X150	570X350X310	12
812-8P	GN1/2X200	0.7	325x265X200	570X350X360	12



3



3

ART NO. 货号	SIZE(MM) 产品规格(MM)	THICKNESS(MM) 厚度(MM)	SPEC.(MM) 产品尺码(MM)	MEAS.(MM) 包装尺码(MM)	PCS/CTNS 每箱数量
823-20P	GN2/3X20	0.6	353x325X20	680X375X70	12
823-40P	GN2/3X40	0.6	353x325X40	680X375X110	12
823-55P	GN2/3X55	0.6	353x325X55	680X375X140	12
823-2P	GN2/3X65	0.6	353x325X65	680X375X140	12
823-4P	GN2/3X100	0.6	353x325X100	680X375X260	12
823-6P	GN2/3X150	0.7	353x325X150	680X375X310	12
823-8P	GN2/3X200	0.7	353x325X200	680X375X360	12



4



4

EUROPE PERFORATED GASTRONORM PAN

HOLE DIA.:3.5mm
欧式打孔不锈钢份数盆
打孔直径: 3.5mm

ART NO. 货号	SIZE(MM) 产品规格(MM)	THICKNESS(MM) 厚度(MM)	SPEC.(MM) 产品尺码(MM)	MEAS.(MM) 包装尺码(MM)	PCS/CTNS 每箱数量
821-20SP	GN2/1X20	0.8	650X530X20	660X545X70	6
821-40SP	GN2/1X40	0.8	650X530X40	660X545X100	6
821-55SP	GN2/1X55	0.8	650X530X55	660X545X130	6
821-2SP	GN2/1X65	0.8	650X530X65	660X545X130	6
821-4SP	GN2/1X100	0.8	650X530X100	660X545X250	6
821-6SP	GN2/1X150	0.8	650X530X150	660X545X310	6
821-8SP	GN2/1X200	0.8	650X530X200	660X545X360	6

ART NO. 货号	SIZE(MM) 产品规格(MM)	THICKNESS(MM) 厚度(MM)	SPEC.(MM) 产品尺码(MM)	MEAS.(MM) 包装尺码(MM)	PCS/CTNS 每箱数量
811-20SP	GN1/1X20	0.6	530X325X20	550X340X50	6
811-40SP	GN1/1X40	0.6	530X325X40	550X340X90	6
811-55SP	GN1/1X55	0.6	530X325X55	550X340X110	6
811-2SP	GN1/1X65	0.6	530X325X65	550X340X110	6
811-4SP	GN1/1X100	0.6	530X325X100	550X340X240	6
811-6SP	GN1/1X150	0.7	530X325X150	550X340X280	6
811-8SP	GN1/1X200	0.7	530X325X200	550X340X340	6

ART NO. 货号	SIZE(MM) 产品规格(MM)	THICKNESS(MM) 厚度(MM)	SPEC.(MM) 产品尺码(MM)	MEAS.(MM) 包装尺码(MM)	PCS/CTNS 每箱数量
812-20SP	GN1/2X20	0.6	325x265X20	570X350X70	12
812-40SP	GN1/2X40	0.6	325x265X40	570X350X110	12
812-55SP	GN1/2X55	0.6	325x265X55	570X350X140	12
812-2SP	GN1/2X65	0.6	325x265X65	570X350X140	12
812-4SP	GN1/2X100	0.6	325x265X100	570X350X260	12
812-6SP	GN1/2X150	0.7	325x265X150	570X350X310	12
812-8SP	GN1/2X200	0.7	325x265X200	570X350X360	12

ART NO. 货号	SIZE(MM) 产品规格(MM)	THICKNESS(MM) 厚度(MM)	SPEC.(MM) 产品尺码(MM)	MEAS.(MM) 包装尺码(MM)	PCS/CTNS 每箱数量
813-20SP	GN1/3X20	0.6	325x176X20	570X350X70	18
813-40SP	GN1/3X40	0.6	325x176X40	570X350X110	18
813-55SP	GN1/3X55	0.6	325x176X55	570X350X140	18
813-2SP	GN1/3X65	0.6	325x176X65	570X350X140	18
813-4SP	GN1/3X100	0.6	325x176X100	570X350X260	18
813-6SP	GN1/3X150	0.7	325x176X150	570X350X310	18
813-8SP	GN1/3X200	0.7	325x176X200	570X350X360	18

ART NO. 货号	SIZE(MM) 产品规格(MM)	THICKNESS(MM) 厚度(MM)	SPEC.(MM) 产品尺码(MM)	MEAS.(MM) 包装尺码(MM)	PCS/CTNS 每箱数量
823-20SP	GN2/3X20	0.6	353x325X20	680X375X70	12
823-40SP	GN2/3X40	0.6	353x325X40	680X375X110	12
823-55SP	GN2/3X55	0.6	353x325X55	680X375X140	12
823-2SP	GN2/3X65	0.6	353x325X65	680X375X140	12
823-4SP	GN2/3X100	0.6	353x325X100	680X375X260	12
823-6SP	GN2/3X150	0.7	353x325X150	680X375X310	12
823-8SP	GN2/3X200	0.7	353x325X200	680X375X360	12



1 EUROPE GASTRONORM PAN COVER

欧式不锈钢份数盆盖

ART NO. 货号	SIZE(MM) 产品规格(MM)	THICKNESS(MM) 厚度(MM)	SPEC.(MM) 产品尺码(MM)	MEAS.(MM) 包装尺码(MM)	PCS/CTNS 每箱数量
821-L	GN2/1 cover	0.9	650X530	660X545X160	6
811-L	GN1/1 cover	0.7	530X325	550X340X160	6
812-L	GN1/2 cover	0.7	325X265	570X350X160	12
813-L	GN1/3 cover	0.7	325X176	570X350X160	18
814-L	GN1/4 cover	0.7	265X162	570X350X160	24
816-L	GN1/6 cover	0.7	176X162	570X350X160	36
819-L	GN1/9 cover	0.7	176X108	480X380X160	48
823-L	GN2/3 cover	0.7	353X325	680X375X160	12
824-L	GN2/4 cover	0.7	530X162	570X360X160	12
8112-L	GN1/12 cover	0.7	132X108	450X260X160	36



1

2 EUROPE GASTRONORM PAN COVER WITH NOTCH

欧式打孔不锈钢份数盆盖

ART NO. 货号	SIZE(MM) 产品规格(MM)	THICKNESS(MM) 厚度(MM)	SPEC.(MM) 产品尺码(MM)	MEAS.(MM) 包装尺码(MM)	PCS/CTNS 每箱数量
821-LN	GN2/1 notch cover	0.9	650X530	660X545X160	6
811-LN	GN1/1 notch cover	0.7	530X325	550X340X160	6
812-LN	GN1/2 notch cover	0.7	325X265	570X350X160	12
813-LN	GN1/3 notch cover	0.7	325X176	570X350X160	18
814-LN	GN1/4 notch cover	0.7	265X162	570X350X160	24
816-LN	GN1/6 notch cover	0.7	176X162	570X350X160	36
819-LN	GN1/9 notch cover	0.7	176X108	480X380X160	48
823-LN	GN2/3 notch cover	0.7	353X325	680X375X160	12
824-LN	GN2/4 notch cover	0.7	530X162	570X360X160	12
8112-LN	GN1/12 notch cover	0.7	132X108	450X260X160	36



2



1b



1a



1c

1a BONDED SILICONE COVER & FOOD PAN

It provides a leak proof system when used with Gastronorm pans.

欧式硅胶树脂密封不锈钢份数盆盖密封性好，具有非常好的保温效果

1b LARGE HANDLE

for easy opening & closing cover
超大手柄

1c BONDED SILICONE

ART NO. 货号	SPEC 产品规格
811-LPR	GN1/1 COVER
812-LPR	GN1/2 COVER
813-LPR	GN1/3 COVER
814-LPR	GN1/4 COVER
816-LPR	GN1/6 COVER
823-LPR	GN2/3 COVER

US steam Pan



1 US STEAM TABLE PAN
TRADITIONAL BODY
美式直身不锈钢份数盆
传统美式直身设计



1

Pan Layouts

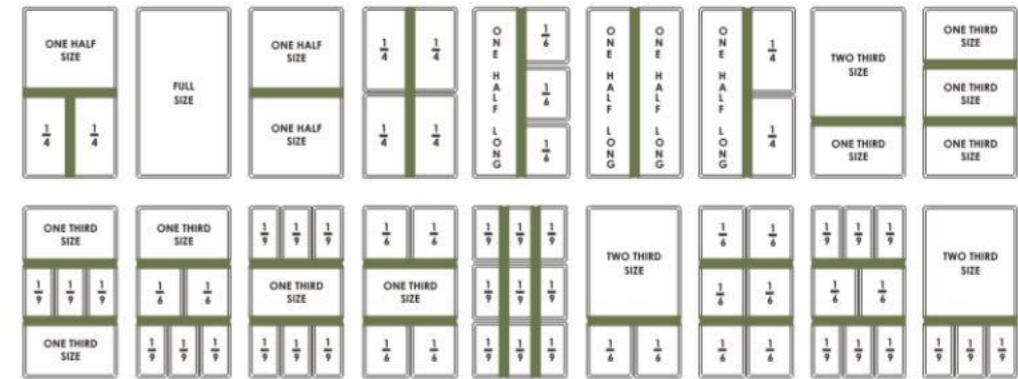

1

ART NO. 货号	SIZE(MM) 产品规格(MM)	THICKNESS(MM) 厚度(MM)	SPEC.(MM) 产品尺码(MM)	MEAS.(MM) 包装尺码(MM)	PCS/CTNS 每箱数量
811-25T	GN1/1X25	0.6	530X325X25	550X340X50	6
811-40T	GN1/1X40	0.6	530X325X40	550X340X90	6
811-2T	GN1/1X65	0.6	530X325X65	550X340X110	6
811-4T	GN1/1X100	0.6	530X325X100	550X340X240	6
811-6T	GN1/1X150	0.6	530X325X150	550X340X280	6
811-8T	GN1/1X200	0.6	530X325X200	550X340X340	6



2

ART NO. 货号	SIZE(MM) 产品规格(MM)	THICKNESS(MM) 厚度(MM)	SPEC.(MM) 产品尺码(MM)	MEAS.(MM) 包装尺码(MM)	PCS/CTNS 每箱数量
812-25T	GN1/2X25	0.6	325x265X25	570X350X70	12
812-40T	GN1/2X40	0.6	325x265X40	570X350X110	12
812-2T	GN1/2X65	0.6	325x265X65	570X350X140	12
812-4T	GN1/2X100	0.6	325x265X100	570X350X260	12
812-6T	GN1/2X150	0.6	325x265X150	570X350X310	12
812-8T	GN1/2X200	0.6	325x265X200	570X350X360	12



3

ART NO. 货号	SIZE(MM) 产品规格(MM)	THICKNESS(MM) 厚度(MM)	SPEC.(MM) 产品尺码(MM)	MEAS.(MM) 包装尺码(MM)	PCS/CTNS 每箱数量
813-2T	GN1/3X65	0.6	325x176X65	570X350X140	18
813-4T	GN1/3X100	0.6	325x176X100	570X350X260	18
813-6T	GN1/3X150	0.6	325x176X150	570X350X310	18
813-8T	GN1/3X200	0.6	325x176X200	570X350X360	18

US steam Pan

ART NO. 货号	SIZE(MM) 产品规格(MM)	THICKNESS(MM) 厚度(MM)	SPEC.(MM) 产品尺码(MM)	MEAS.(MM) 包装尺码(MM)	PCS/CTNS 每箱数量
814-2T	GN1/4X65	0.6	265x162X65	570X350X140	24
814-4T	GN1/4X100	0.6	265x162X100	570X350X260	24
814-6T	GN1/4X150	0.6	265x162X150	570X350X310	24
814-8T	GN1/4X200	0.6	265x162X200	570X350X360	24



ART NO. 货号	SIZE(MM) 产品规格(MM)	THICKNESS(MM) 厚度(MM)	SPEC.(MM) 产品尺码(MM)	MEAS.(MM) 包装尺码(MM)	PCS/CTNS 每箱数量
8118-80T	GN1/18-80	0.7	108X88X80	230X190X275	36
8118-100T	GN1/18-100	0.7	108X88X100	230X190X310	36
8118-LT	GN1/18-COVER	0.7	108X88	230X190X160	36

ART NO. 货号	SIZE(MM) 产品规格(MM)	THICKNESS(MM) 厚度(MM)	SPEC.(MM) 产品尺码(MM)	MEAS.(MM) 包装尺码(MM)	PCS/CTNS 每箱数量
816-2T	GN1/6X65	0.6	176x162X65	570X350X140	36
816-4T	GN1/6X100	0.6	176x162X100	570X350X260	36
816-6T	GN1/6X150	0.6	176x162X150	570X350X310	36
816-8T	GN1/6X200	0.6	176x162X200	570X350X360	36



2 DIVIDED PAN 美式两格物盆

ART NO. 货号	SIZE(MM) 产品规格(MM)	THICKNESS(MM) 厚度(MM)	SPEC.(MM) 产品尺码(MM)	MEAS.(MM) 包装尺码(MM)	PCS/CTNS 每箱数量
811-2TX2	GN1/1X2-65	0.7	530X325X65	550x340x110	12
811-4TX2	GN1/1X2-100	0.7	530X325X100	550x340x170	12

ART NO. 货号	SIZE(MM) 产品规格(MM)	THICKNESS(MM) 厚度(MM)	SPEC.(MM) 产品尺码(MM)	MEAS.(MM) 包装尺码(MM)	PCS/CTNS 每箱数量
819-2T	GN1/9X65	0.6	176x108X65	480X380X140	48
819-4T	GN1/9X100	0.6	176x108X100	480X380X260	48
819-6T	GN1/9X150	0.6	176x108X150	480X380X310	48



3 PERFORATED STEAM TABLE PAN 美式打孔不锈钢份数盆 HOLE DIA.:5MM 打孔直径: 5MM

ART NO. 货号	SIZE(MM) 产品规格(MM)	THICKNESS(MM) 厚度(MM)	SPEC.(MM) 产品尺码(MM)	MEAS.(MM) 包装尺码(MM)	PCS/CTNS 每箱数量
811-25TP	GN1/1X25	0.6	530X325X25	550X340X50	6
811-40TP	GN1/1X40	0.6	530X325X40	550X340X90	6
811-2TP	GN1/1X65	0.6	530X325X65	550X340X110	6
811-4TP	GN1/1X100	0.6	530X325X100	550X340X240	6
811-6TP	GN1/1X150	0.6	530X325X150	550X340X280	6
811-8TP	GN1/1X200	0.6	530X325X200	550X340X340	6

ART NO. 货号	SIZE(MM) 产品规格(MM)	THICKNESS(MM) 厚度(MM)	SPEC.(MM) 产品尺码(MM)	MEAS.(MM) 包装尺码(MM)	PCS/CTNS 每箱数量
823-25T	GN2/3X25	0.6	353x325X25	680X375X70	12
823-40T	GN2/3X40	0.6	353x325X40	680X375X110	12
823-2T	GN2/3X65	0.6	353x325X65	680X375X140	12
823-4T	GN2/3X100	0.6	353x325X100	680X375X260	12
823-6T	GN2/3X150	0.6	353x325X150	680X375X310	12
823-8T	GN2/3X200	0.6	353x325X200	680X375X360	12



ART NO. 货号	SIZE(MM) 产品规格(MM)	THICKNESS(MM) 厚度(MM)	SPEC.(MM) 产品尺码(MM)	MEAS.(MM) 包装尺码(MM)	PCS/CTNS 每箱数量
812-25TP	GN1/2X25	0.6	325x265X25	570X350X70	12
812-40TP	GN1/2X40	0.6	325x265X40	570X350X110	12
812-2TP	GN1/2X65	0.6	325x265X65	570X350X140	12
812-4TP	GN1/2X100	0.6	325x265X100	570X350X260	12
812-6TP	GN1/2X150	0.6	325x265X150	570X350X310	12
812-8TP	GN1/2X200	0.6	325x265X200	570X350X360	12

US steam Pan

PERFORATED STEAM TABLE PAN

美式打孔不锈钢份数盆
HOLE DIA.:3.5mm
打孔直径: 3.5mm

ART NO. 货号	SIZE(MM) 产品规格(MM)	THICKNESS(MM) 厚度(MM)	SPEC.(MM) 产品尺码(MM)	MEAS.(MM) 包装尺码(MM)	PCS/CTNS 每箱数量
811-25TSP	GN1/1X25	0.6	530X325X25	550X340X50	6
811-40TSP	GN1/1X40	0.6	530X325X40	550X340X90	6
811-2TSP	GN1/1X65	0.6	530X325X65	550X340X110	6
811-4TSP	GN1/1X100	0.6	530X325X100	550X340X240	6
811-6TSP	GN1/1X150	0.6	530X325X150	550X340X280	6
811-8TSP	GN1/1X200	0.6	530X325X200	550X340X340	6



1

ART NO. 货号	SIZE(MM) 产品规格(MM)	THICKNESS(MM) 厚度(MM)	SPEC.(MM) 产品尺码(MM)	MEAS.(MM) 包装尺码(MM)	PCS/CTNS 每箱数量
812-25TSP	GN1/2X25	0.6	325x265X25	570X350X70	12
812-40TSP	GN1/2X40	0.6	325x265X40	570X350X110	12
812-2TSP	GN1/2X65	0.6	325x265X65	570X350X140	12
812-4TSP	GN1/2X100	0.6	325x265X100	570X350X260	12
812-6TSP	GN1/2X150	0.6	325x265X150	570X350X310	12
812-8TSP	GN1/2X200	0.6	325x265X200	570X350X360	12



1

ART NO. 货号	SIZE(MM) 产品规格(MM)	THICKNESS(MM) 厚度(MM)	SPEC.(MM) 产品尺码(MM)	MEAS.(MM) 包装尺码(MM)	PCS/CTNS 每箱数量
813-2TSP	GN1/3X25	0.6	325x176X65	570X350X140	18
813-4TSP	GN1/3X40	0.6	325x176X100	570X350X260	18
813-6TSP	GN1/3X65	0.6	325x176X150	570X350X310	18
813-8TSP	GN1/3X100	0.6	325x176X200	570X350X360	18



3

US steam Pan



US STEAM TABLE PAN COVER

美式直身不锈钢份数盆盖

ART NO. 货号	SIZE(MM) 产品规格(MM)	THICKNESS(MM) 厚度(MM)	SPEC.(MM) 产品尺码(MM)	MEAS.(MM) 包装尺码(MM)	PCS/CTNS 每箱数量
811-LT	GN1/1 cover	0.6	530X325	550X340X160	6
812-LT	GN1/2 cover	0.6	325X265	570X350X160	12
813-LT	GN1/3 cover	0.6	325X176	570X350X160	18
814-LT	GN1/4 cover	0.6	265X162	570X350X160	24
816-LT	GN1/6 cover	0.6	176X162	570X350X160	36
819-LT	GN1/9 cover	0.6	176X108	480X380X160	48
823-LT	GN2/3 cover	0.6	353X325	680X375X160	12



1

US STEAM TABLE PAN COVER WITH NOTCH

美式开孔不锈钢份数盆盖

ART NO. 货号	SIZE(MM) 产品规格(MM)	THICKNESS(MM) 厚度(MM)	SPEC.(MM) 产品尺码(MM)	MEAS.(MM) 包装尺码(MM)	PCS/CTNS 每箱数量
811-LTN	GN1/1 notch cover	0.6	530X325	550X340X160	6
812-LTN	GN1/2 notch cover	0.6	325X265	570X350X160	12
813-LTN	GN1/3 notch cover	0.6	325X176	570X350X160	18
814-LTN	GN1/4 notch cover	0.6	265X162	570X350X160	24
816-LTN	GN1/6 notch cover	0.6	176X162	570X350X160	36
819-LTN	GN1/9 notch cover	0.6	176X108	480X380X160	48
823-LTN	GN2/3 notch cover	0.6	353X325	680X375X160	12



2

US steam Pan

US ANTI-JAM PAN

美式防挤不锈钢份数盆

STACKING & ANTI-JAM FUNCTION

STACKABLE, PREVENT JAMMING DURING STORAGE, EASY TO TAKE OUT

盆身防挤设计
在叠放时，防止盆与盆之间吸住，
方便使用



1

Pan Layouts

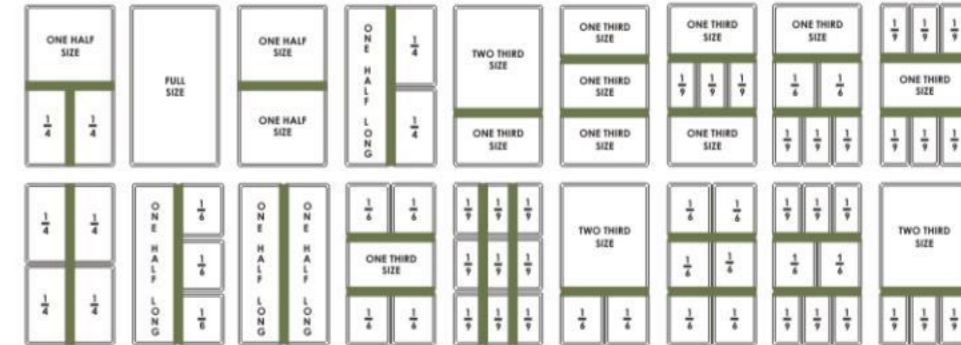

ART NO. 货号	SIZE(MM) 产品规格(MM)	THICKNESS(MM) 厚度(MM)	SPEC.(MM) 产品尺码(MM)	MEAS.(MM) 包装尺码(MM)	PCS/CTNS 每箱数量
811-25T	GN1/1X25	0.6	530X325X25	550X340X50	6
811-40T	GN1/1X40	0.6	530X325X40	550X340X90	6
811-2CT	GN1/1X65	0.6	530X325X65	550X340X150	6
811-4CT	GN1/1X100	0.6	530X325X100	550X340X210	6
811-6CT	GN1/1X150	0.6	530X325X150	550X340X270	6
811-8CT	GN1/1X200	0.6	530X325X200	550X340X340	6



1

ART NO. 货号	SIZE(MM) 产品规格(MM)	THICKNESS(MM) 厚度(MM)	SPEC.(MM) 产品尺码(MM)	MEAS.(MM) 包装尺码(MM)	PCS/CTNS 每箱数量
812-25T	GN1/2X25	0.6	325x265X25	570X350X70	12
812-40T	GN1/2X40	0.6	325x265X40	570X350X110	12
812-2CT	GN1/2X65	0.6	325x265X65	570X350X160	12
812-4CT	GN1/2X100	0.6	325x265X100	570X350X220	12
812-6CT	GN1/2X150	0.6	325x265X150	570X350X310	12
812-8CT	GN1/2X200	0.6	325x265X200	570X350X360	12



2

ART NO. 货号	SIZE(MM) 产品规格(MM)	THICKNESS(MM) 厚度(MM)	SPEC.(MM) 产品尺码(MM)	MEAS.(MM) 包装尺码(MM)	PCS/CTNS 每箱数量
813-2CT	GN1/3X65	0.6	325x176X65	570X350X180	18
813-4CT	GN1/3X100	0.6	325x176X100	570X350X220	18
813-6CT	GN1/3X150	0.6	325x176X150	570X350X310	18
813-8CT	GN1/3X200	0.6	325x176X200	570X350X360	18



3

US anti jam pan

ART NO. 货号	SIZE(MM) 产品规格(MM)	THICKNESS(MM) 厚度(MM)	SPEC.(MM) 产品尺码(MM)	MEAS.(MM) 包装尺码(MM)	PCS/CTNS 每箱数量
814-2CT	GN1/4X65	0.6	265x162X65	570X350X180	24
814-4CT	GN1/4X100	0.6	265x162X100	570X350X220	24
814-6CT	GN1/4X150	0.6	265x162X150	570X350X310	24
814-8CT	GN1/4X200	0.6	265x162X200	570X350X360	24



1

ART NO. 货号	SIZE(MM) 产品规格(MM)	THICKNESS(MM) 厚度(MM)	SPEC.(MM) 产品尺码(MM)	MEAS.(MM) 包装尺码(MM)	PCS/CTNS 每箱数量
816-2CT	GN1/6X65	0.6	176x162X65	570X350X180	36
816-4CT	GN1/6X100	0.6	176x162X100	570X350X220	36
816-6CT	GN1/6X150	0.6	176x162X150	570X350X310	36
816-8CT	GN1/6X200	0.6	176x162X200	570X350X360	36



2

ART NO. 货号	SIZE(MM) 产品规格(MM)	THICKNESS(MM) 厚度(MM)	SPEC.(MM) 产品尺码(MM)	MEAS.(MM) 包装尺码(MM)	PCS/CTNS 每箱数量
819-2CT	GN1/9X65	0.6	176x108X65	480X380X140	48
819-4CT	GN1/9X100	0.6	176x108X100	480X380X260	48
819-6CT	GN1/9X150	0.6	176x108X150	480X380X310	48



3

ART NO. 货号	SIZE(MM) 产品规格(MM)	THICKNESS(MM) 厚度(MM)	SPEC.(MM) 产品尺码(MM)	MEAS.(MM) 包装尺码(MM)	PCS/CTNS 每箱数量
823-25T	GN2/3X25	0.6	353x325X25	680X375X70	12
823-40T	GN2/3X40	0.6	353x325X40	680X375X110	12
823-2CT	GN2/3X65	0.6	353x325X65	680X375X140	12
823-4CT	GN2/3X100	0.6	353x325X100	680X375X260	12
823-6CT	GN2/3X150	0.6	353x325X150	680X375X310	12
823-8CT	GN2/3X200	0.6	353x325X200	680X375X360	12



4



1



2



3



4

1 PERFORATED ANTI-JAM PAN

美式打孔不锈钢份数盆
HOLE DIA.:5MM
打孔直径: 5MM

ART NO. 货号	SIZE(MM) 产品规格(MM)	THICKNESS(MM) 厚度(MM)	SPEC.(MM) 产品尺码(MM)	MEAS.(MM) 包装尺码(MM)	PCS/CTNS 每箱数量
811-25TP	GN1/1X25	0.6	530X325X25	550X340X50	6
811-40TP	GN1/1X40	0.6	530X325X40	550X340X90	6
811-2CTP	GN1/1X65	0.6	530X325X65	550X340X150	6
811-4CTP	GN1/1X100	0.6	530X325X100	550X340X210	6
811-6CTP	GN1/1X150	0.6	530X325X150	550X340X270	6
811-8CTP	GN1/1X200	0.6	530X325X200	550X340X340	6

2

ART NO. 货号	SIZE(MM) 产品规格(MM)	THICKNESS(MM) 厚度(MM)	SPEC.(MM) 产品尺码(MM)	MEAS.(MM) 包装尺码(MM)	PCS/CTNS 每箱数量
812-25TP	GN1/2X25	0.6	325x265X25	570X350X70	12
812-40TP	GN1/2X40	0.6	325x265X40	570X350X110	12
812-2CTP	GN1/2X65	0.6	325x265X65	570X350X160	12
812-4CTP	GN1/2X100	0.6	325x265X100	570X350X220	12
812-6CTP	GN1/2X150	0.6	325x265X150	570X350X310	12
812-8CTP	GN1/2X200	0.6	325x265X200	570X350X360	12

3 PERFORATED ANTI-JAM PAN

美式打孔不锈钢份数盆
HOLE DIA.:3.5MM
打孔直径: 3.5MM

ART NO. 货号	SIZE(MM) 产品规格(MM)	THICKNESS(MM) 厚度(MM)	SPEC.(MM) 产品尺码(MM)	MEAS.(MM) 包装尺码(MM)	PCS/CTNS 每箱数量
811-25TSP	GN1/1X25	0.6	530X325X25	550X340X50	6
811-40TSP	GN1/1X40	0.6	530X325X40	550X340X90	6
811-2CTSP	GN1/1X65	0.6	530X325X65	550X340X150	6
811-4CTSP	GN1/1X100	0.6	530X325X100	550X340X210	6
811-6CTSP	GN1/1X150	0.6	530X325X150	550X340X270	6
811-8CTSP	GN1/1X200	0.6	530X325X200	550X340X340	6

4

ART NO. 货号	SIZE(MM) 产品规格(MM)	THICKNESS(MM) 厚度(MM)	SPEC.(MM) 产品尺码(MM)	MEAS.(MM) 包装尺码(MM)	PCS/CTNS 每箱数量
812-25TSP	GN1/2X25	0.6	325x265X25	570X350X70	12
812-40TSP	GN1/2X40	0.6	325x265X40	570X350X110	12
812-2CTSP	GN1/2X65	0.6	325x265X65	570X350X160	12
812-4CTSP	GN1/2X100	0.6	325x265X100	570X350X220	12
812-6CTSP	GN1/2X150	0.6	325x265X150	570X350X310	12
812-8CTSP	GN1/2X200	0.6	325x265X200	570X350X360	12

ST/ST BAIN-MARIE PAN 酱汁盆

ART NO. 货号	THICKNESS(MM) 厚度(MM)	SPEC.(MM) 产品尺码(MM)	MEAS.(MM) 包装尺码(MM)	PCS/CTNS 每箱数量
0819-160	0.9	155X105X160	570x480x210	12
0819-75	0.9	155X105X75	570x480x120	12
0819-55	0.9	155X105X55	570x480x100	12
0819-L	0.9	155X105		



1

ST/ST BAIN-MARIE PAN 酱汁盆

ART NO. 货号	THICKNESS(MM) 厚度(MM)	SPEC.(MM) 产品尺码(MM)	MEAS.(MM) 包装尺码(MM)	PCS/CTNS 每箱数量
0816-235	0.9	155X155X235	680x585x280	12
0816-160	0.9	155X155X160	680x585x210	12
0816-75	0.9	155X155X75	680x585x120	12
0816-L	0.9	155X155		



2

ST/ST BAIN-MARIE PAN 酱汁盆

ART NO. 货号	THICKNESS(MM) 厚度(MM)	SPEC.(MM) 产品尺码(MM)	MEAS.(MM) 包装尺码(MM)	PCS/CTNS 每箱数量
0824-235	0.9	240X240X235	765x550x280	6
0824-160	0.9	240X240X160	765x550x210	6
0824-75	0.9	240X240X75	765x550x120	6
0824-L	0.9	240X240		



3

ICEAM CREAM PAN WITH ANTI-JAM 防挤雪糕盆

ART NO. 货号	THICKNESS(MM) 厚度(MM)	SPEC.(MM) 产品尺码(MM)	MEAS.(MM) 包装尺码(MM)	PCS/CTNS 每箱数量
1/2 IC	0.8	360X250X150	530x385x300	10
1/3 IC	0.8	360X165X115	385x360x270	10



4

ICEAM CREAM PAN W/O ANTI-JAM 直身雪糕盆

ART NO. 货号	THICKNESS(MM) 厚度(MM)	SPEC.(MM) 产品尺码(MM)	MEAS.(MM) 包装尺码(MM)	PCS/CTNS 每箱数量
1/2 ICS	0.8	360X250X150	530x385x300	10
1/3 ICS	0.8	360X165X118	385x360x270	10



5



1



2



3



4



5



6

ICE CREAM PAN 不锈钢雪糕盆

ART NO. 货号	THICKNESS(MM) 厚度(MM)	SPEC.(MM) 产品尺码(MM)
816-2XT	0.6	250X210X65
816-4XT	0.6	250X210X100

ICE CREAM PAN 不锈钢雪糕盆

ART NO. 货号	THICKNESS(MM) 厚度(MM)	SPEC.(MM) 产品尺码(MM)
834-2N	0.6	420X255X65
834-4N	0.6	420X255X100
834-6N	0.6	420X255X150
C834-LT	0.7	420X255

SPILLAGE PAN 21L大水盆

ART NO. 货号	THICKNESS(MM) 厚度(MM)	SPEC.(MM) 产品尺码(MM)	MEAS.(MM) 包装尺码(MM)	PCS/CTNS 每箱数量
811-21L	0.7	535X330X150	570x350x360	6

SPILLAGE PAN 平边盆

ART NO. 货号	SIZE(MM) 产品规格(MM)	THICKNESS(MM) 厚度(MM)	SPEC.(MM) 产品尺码(MM)	MEAS.(MM) 包装尺码(MM)	PCS/CTNS 每箱数量
F811-10	GN1/1X10	0.7	530X325X10	550X340X30	6
F811-20	GN1/1X20	0.7	530X325X20	550X340X50	6
F811-40	GN1/1X40	0.7	530X325X40	550X340X90	6
F811-2	GN1/1X65	0.7	530X325X65	550X340X110	6

1/1 HINGED COVER 1/1折合盖

ART NO. 货号	THICKNESS(MM) 厚度(MM)	SPEC.(MM) 产品尺码(MM)	MEAS.(MM) 包装尺码(MM)	PCS/CTNS 每箱数量
1/1HC	0.6	535X330X65	545X340X530	12

1/2 HINGED COVER 1/2折合盖

ART NO. 货号	THICKNESS(MM) 厚度(MM)	SPEC.(MM) 产品尺码(MM)	MEAS.(MM) 包装尺码(MM)	PCS/CTNS 每箱数量
1/2HC	0.6	530X325X10	540x340x340	12

■ OBLONG SUSHI PLATTER 方型寿司碟

ART NO. 货号	THICKNESS(MM) 厚度(MM)	SPEC.(MM) 产品尺码(MM)	MEAS.(MM) 包装尺码(MM)	PCS/CTNS 每箱数量
11475	0.8	530X325X35	328x533x43	1



1

■ ROUND SUSHI PLATTER 圆型寿司碟

ART NO. 货号	THICKNESS(MM) 厚度(MM)	SPEC.(MM) 产品尺码(MM)	MEAS.(MM) 包装尺码(MM)	PCS/CTNS 每箱数量
11470	0.8	480X480X50	483x483x48	1



2

■ ROUND TRAY 圆型托盘

ART NO. 货号	THICKNESS(MM) 厚度(MM)	SPEC.(MM) 产品尺码(MM)	MEAS.(MM) 包装尺码(MM)	PCS/CTNS 每箱数量
1437	1.2	445x445x25	460x460x70	5



3

■ RECTANGLE TRAY 方型托盘

ART NO. 货号	THICKNESS(MM) 厚度(MM)	SPEC.(MM) 产品尺码(MM)	MEAS.(MM) 包装尺码(MM)	PCS/CTNS 每箱数量
1434(小号)	1.2	530X325X25	550x340x80	5
1435(中号)	1.2	600X400X25	615x410x80	5
1436(大号)	1.3	645X525X25	670x550x80	5



4

■ SHEET PAN 方型浅盆

ART NO. 货号	THICKNESS(MM) 厚度(MM)	SPEC.(MM) 产品尺码(MM)	MEAS.(MM) 包装尺码(MM)	PCS/CTNS 每箱数量
811-25C	1.0	455X330X25	470x350x60	6
821-25C	1.0	660X455X25	680x480x60	6



5



1



2



3



4



5

■ ROUND APAPTOR PLATES 1030固定罩/YH730固定罩

ART NO. 货号	THICKNESS(MM) 厚度(MM)	SPEC.(MM) 产品尺码(MM)	MEAS.(MM) 包装尺码(MM)	PCS/CTNS 每箱数量
1030P	1.2	390X390X30	400X400X130	12
YH730P	0.9	390X390X30	400X400X130	12

■ APAPTOR PLATES 1038固定罩/YH738P固定罩

ART NO. 货号	THICKNESS(MM) 厚度(MM)	SPEC.(MM) 产品尺码(MM)	MEAS.(MM) 包装尺码(MM)	PCS/CTNS 每箱数量
1038P	1.2	535X340X30	545X350X150	12
YH738P	0.9	535X340X30	545X350X150	12

■ 10L DELUXE SOUP BUCKET 10L豪华汤桶

ART NO. 货号	THICKNESS(MM) 厚度(MM)	SPEC.(MM) 产品尺码(MM)	MEAS.(MM) 包装尺码(MM)	PCS/CTNS 每箱数量
1030SB	0.9	360X300X270	900x610x230	6
YH730SB	0.7	360X300X270	900x610x230	6

■ 4.5L DELUXE SOUP BUCKET 4.5L豪华汤桶

ART NO. 货号	THICKNESS(MM) 厚度(MM)	SPEC.(MM) 产品尺码(MM)	MEAS.(MM) 包装尺码(MM)	PCS/CTNS 每箱数量
1038SB	0.9	295X240X220	700x490x95	6
YH738SB	0.7	295X240X220	700x490x95	6

■ SOUP BUCKET 汤桶

ART NO. 货号	THICKNESS(MM) 厚度(MM)	SPEC.(MM) 产品尺码(MM)	MEAS.(MM) 包装尺码(MM)	PCS/CTNS 每箱数量
4L	0.6	190X190X215	390X390X480	24
7L	0.6	240X240X215	490X490X520	24
11L	0.6	290X290X215	590X590X530	24
4LC	0.6	190X190	400X210X210	24
7LC	0.6	240X240	500X260X210	24
11LC	0.6	290X290	600X310X210	24

ANGLED ADAPTOR PLATES 不锈钢斜盘架

ART NO. 货号	THICKNESS(MM) 厚度(MM)	SPEC.(MM) 产品尺码(MM)	MEAS.(MM) 包装尺码(MM)	PCS/CTNS 每箱数量
V531	1.2	530X320X80	560X350X350	6

Chopping Board Rack 不锈钢砧板架

ART NO. 型号	THICKNESS(MM) 厚度(MM)	SPEC.(MM) 产品尺码(MM)	MEAS.(MM) 包装尺码(MM)	PCS/CTNS 每箱数量
J251	0.9	230X210X190 (0.52")	550X430X240	20

LABEL DISPENSER 不锈钢商标架

ART NO. 货号	SPEC.(MM) 产品尺码(MM)	MEAS.(MM) 包装尺码(MM)	PCS/CTNS 每箱数量
LD001	240X190X120(1 3/4")	595X250X270	6

811-L

STAINLESS STEEL SINK 洗手盆(星盆)

ART NO. 货号	THICKNESS(MM) 厚度(MM)	SPEC.(MM) 产品尺码(MM)
8600-250	1.0	600X600X250
8600-300	1.0	600X600X300

STAINLESS STEEL SINK 洗手盆(星盆)

ART NO. 货号	THICKNESS(MM) 厚度(MM)	SPEC.(MM) 产品尺码(MM)
8500-250	1.0	500X500X250
8500-300	1.0	500X500X300

STAINLESS STEEL SINK 洗手盆(星盆)

ART NO. 货号	THICKNESS(MM) 厚度(MM)	SPEC.(MM) 产品尺码(MM)
8450-250	1.0	450X450X250
8450-300	1.0	450X450X300

STAINLESS STEEL SINK 洗手盆(星盆)

ART NO. 货号	THICKNESS(MM) 厚度(MM)	SPEC.(MM) 产品尺码(MM)
8400-250	1.0	400X400X250
8400-300	1.0	400X400X300



1



2



3



4



5



6



7



1



2



3



4



5



6

GN Pan 1/6 Size Regular with Rubber Bar 不锈钢咖啡渣盆

ART NO. 货号	THICKNESS(MM) 厚度(MM)	SPEC.(MM) 产品尺码(MM)	MEAS.(MM) 包装尺码(MM)	PCS/CTNS 每箱数量
D43	0.7	176x162X150	700X570X330	24

4.5L FRY PAN 4.5L 椭圆炸炉胆

ART NO. 货号	THICKNESS(MM) 厚度(MM)	SPEC.(MM) 产品尺码(MM)	MEAS.(MM) 包装尺码(MM)	PCS/CTNS 每箱数量
4.5LFP	0.6	300X215X175	650X320X440	24

1/3 FRY PAN 1/3 炸炉胆

ART NO. 货号	THICKNESS(MM) 厚度(MM)	SPEC.(MM) 产品尺码(MM)	MEAS.(MM) 包装尺码(MM)	PCS/CTNS 每箱数量
1/3X125	0.6	320X170X125	630X340X370	24
1/3X150	0.6	320X170X150	630X340X370	24
1/3X165	0.6	320X170X165	630X340X370	24
1/3X185	0.6	320X170X185	630X340X370	24
1/3X200	0.7	320X170X200	630X340X370	24

ROUND FOOD PAN 6L 圆形物盆

ART NO. 货号	THICKNESS(MM) 厚度(MM)	SPEC.(MM) 产品尺码(MM)	MEAS.(MM) 包装尺码(MM)	PCS/CTNS 每箱数量
721F	0.7	Φ385X65	400x400x395	12

6L DIVIDED PAN 6L 圆形分隔物盆

ART NO. 货号	THICKNESS(MM) 厚度(MM)	SPEC.(MM) 产品尺码(MM)	MEAS.(MM) 包装尺码(MM)	PCS/CTNS 每箱数量
839DF	0.7	Φ385X65	400x400x130	10

4L DIVIDED PAN 4L 圆形分隔物盆

ART NO. 货号	THICKNESS(MM) 厚度(MM)	SPEC.(MM) 产品尺码(MM)	MEAS.(MM) 包装尺码(MM)	PCS/CTNS 每箱数量
831DF	0.7	Φ340X65	360x360x100	6

1 DRAIN SHELF 不锈钢隔板

ART NO. 货号	THICKNESS(MM) 厚度(MM)	SPEC.(MM) 产品尺码(MM)	MEAS.(MM) 包装尺码(MM)	PCS/CTNS 每箱数量
PUN11	0.8	465X270X15	480X290X190	10
PUN12	0.8	270x210x15	285x225x100	10



1

2 DRAIN PLATE 不锈钢隔板

ART NO. 货号	THICKNESS(MM) 厚度(MM)	SPEC.(MM) 产品尺码(MM)	MEAS.(MM) 包装尺码(MM)	PCS/CTNS 每箱数量
81110	0.8	385X230X60	450x300x150	20



2

3 APARTOR PLATES 不锈钢固定罩

ART NO. 货号	THICKNESS(MM) 厚度(MM)	SPEC.(MM) 产品尺码(MM)	MEAS.(MM) 包装尺码(MM)	PCS/CTNS 每箱数量
728P	0.8	530X335X20	540X345X150	12



3

4 ALUMINIUM BILL HOLDER 高级铝价目挂架

ART NO. 货号	SPEC.(MM) 产品尺码(MM)	MEAS.(MM) 包装尺码(MM)	PCS/CTNS 每箱数量
BH-12	360x60X20	380X280X200	24
BH-18	450X60X20	530X280X200	24
BH-24	600X60X20	680X280X200	24
BH-36	900X60X20	990X280X200	24
BH-40	1000X60X20	1090X280X200	24
BH-48	1200X60X20	1290X280X200	24



4

5 APARTOR BAR 不锈钢间隔钢条

ART NO. 货号	THICKNESS(MM) 厚度(MM)	SPEC.(MM) 产品尺码(MM)	MEAS.(MM) 包装尺码(MM)	PCS/CTNS 每箱数量
ADP-21	0.9	530X25X10	560X250X120	144
ADP-12	0.9	325X25X10	330X250X120	144



5



1

1 FUEL HOLDER 不锈钢蜡盅

ART NO. 货号	THICKNESS(MM) 厚度(MM)	SPEC.(MM) 产品尺码(MM)	MEAS.(MM) 包装尺码(MM)	PCS/CTNS 每箱数量
800F	0.6	170X90X65	530X420X220	50



2

10 ELECTRICAL WARMER

电热板
200MM(W) X 302MM (H)
700W. 110V OR 220V

3 INDUCTION COOKER

电磁炉
HL-C05H
Φ185MM X 75MM(H)
700W

HL-C10K
Φ245MM X 65MM(H)
1000W



3

VITRIFIED NON-POROUS PORCELAIN FOOD PAN

强化瓷食物盆
GN 1/1 FOOD PAN 9Ltr 陶瓷盆

ART NO. 货号	SPEC.(MM) 产品尺码(MM)	MEAS.(MM) 包装尺码(MM)	PCS/CTNS 每箱数量
P811-2	530X325X65	570x330x360	4



1

VITRIFIED NON-POROUS PORCELAIN FOOD PAN

强化瓷食物盆
GN 1/2 FOOD PAN 4Ltr 陶瓷盆

ART NO. 货号	SPEC.(MM) 产品尺码(MM)	MEAS.(MM) 包装尺码(MM)	PCS/CTNS 每箱数量
P812-2	325X265X65	530x360x300	6



2

VITRIFIED NON-POROUS PORCELAIN FOOD PAN

强化瓷食物盆
GN 2/3 FOOD PAN 6Ltr 陶瓷盆

ART NO. 货号	SPEC.(MM) 产品尺码(MM)	MEAS.(MM) 包装尺码(MM)	PCS/CTNS 每箱数量
P823-2	353X325X65	395x350x350	4



3

VITRIFIED NON-POROUS PORCELAIN FOOD PAN

强化瓷食物盆
GN 2/3 DIVIDED FOOD PAN 6Ltr 陶瓷盆

ART NO. 货号	SPEC.(MM) 产品尺码(MM)	MEAS.(MM) 包装尺码(MM)	PCS/CTNS 每箱数量
P823/2-2	353X325X65	380x330x350	4



4

VITRIFIED NON-POROUS PORCELAIN FOOD PAN

强化瓷食物盆
GN 1/3 FOOD PAN 2.5Ltr 陶瓷盆

ART NO. 货号	SPEC.(MM) 产品尺码(MM)	MEAS.(MM) 包装尺码(MM)	PCS/CTNS 每箱数量
P813-2	325X176X65	520x350x390	12



5

VITRIFIED NON-POROUS PORCELAIN FOOD PAN

强化瓷食物盆
Φ33CM ROUND FOOD PAN, 6Ltr 陶瓷盆

ART NO. 货号	SPEC.(MM) 产品尺码(MM)	MEAS.(MM) 包装尺码(MM)	PCS/CTNS 每箱数量
PRF36-2	Φ390X65	440x360x410	4



6



1



2



3



4



5



6



7

VITRIFIED NON-POROUS PORCELAIN FOOD PAN

强化瓷食物盆
Φ33CM DIVIDED ROUND FOOD PAN, 5.8Ltr 陶瓷盆

ART NO. 货号	SPEC.(MM) 产品尺码(MM)	MEAS.(MM) 包装尺码(MM)	PCS/CTNS 每箱数量
PRF36/2-2	Φ390X65	430x360x430	4

VITRIFIED NON-POROUS PORCELAIN FOOD PAN

强化瓷食物盆
Φ28CM ROUND FOOD PAN, 4Ltr 陶瓷盆

ART NO. 货号	SPEC.(MM) 产品尺码(MM)	MEAS.(MM) 包装尺码(MM)	PCS/CTNS 每箱数量
PRF28-2	Φ330X65	530x400x360	4

VITRIFIED NON-POROUS PORCELAIN FOOD PAN

强化瓷食物盆
Φ28CM ROUND DIVIDED FOOD PAN, 4Ltr 陶瓷盆

ART NO. 货号	SPEC.(MM) 产品尺码(MM)	MEAS.(MM) 包装尺码(MM)	PCS/CTNS 每箱数量
PRF28/2-2	Φ330X65	558x400x360	4

OPTIONAL ACCESSORIES:

VITRIFIED NON-POROUS PORCELAIN GRAVY POT
强化瓷酱汁盆
Φ24CM GRAVY POT, 4Ltr 酱汁盆

ART NO. 货号	SPEC.(MM) 产品尺码(MM)	MEAS.(MM) 包装尺码(MM)	PCS/CTNS 每箱数量
LPRF24-6	Φ240X153	620x430x320	4

OPTIONAL ACCESSORIES:

VITRIFIED NON-POROUS PORCELAIN GRAVY POT
强化瓷酱汁盆
Φ30CM GRAVY POT, 6Ltr 酱汁盆

ART NO. 货号	SPEC.(MM) 产品尺码(MM)	MEAS.(MM) 包装尺码(MM)	PCS/CTNS 每箱数量
LPRF30-6	Φ300X153	730x435x385	4

10" STEAMER 10" 蒸笼

ART NO. 货号	SPEC.(MM) 产品尺码(MM)	MEAS.(MM) 包装尺码(MM)	PCS/CTNS 每箱数量
10" W/ADAPTOR 10" 蒸笼连固定罩	Φ388X155	400X400X115	1 SET

8" STEAMER 8" 蒸笼

ART NO. 货号	SPEC.(MM) 产品尺码(MM)	MEAS.(MM) 包装尺码(MM)	PCS/CTNS 每箱数量
8" W/ADAPTOR 8" 蒸笼连固定罩	535x338x148	545x348x115	1 SET